

**Multiphysics
Computational Fluid Dynamics Solution**
Product Brochure



Cradle CFD



Cradle | scSTREAM



Cradle | HeatDesigner



Cradle | scFLOW



Cradle | SC / Tetra



Cradle | scPOST



Cradle | PICLS

The Role of CFD in Engineering

One of the foremost expectations of today's successful product driven companies is that they bring high value-added products, that meet customer needs, quickly to the market. In addition, successful companies proactively identify application scenarios that could result in unsatisfactory performance, product failures, customer dissatisfaction and/or develop design solutions that mitigate the potential risks.

Thermo-fluid analysis software

Since software simulation enables predicting performance without creating a hardware prototype, the tools can be used early in the planning state of product development to sift through preliminary design concepts. Simulation can also be used to predict performance of products where it is difficult to make experimental measurements. In addition, simulation software can be used to visualize invisible fluid flow and heat transfer. This results in increased engineering understanding while providing a vehicle for communicating this knowledge to non-experts.

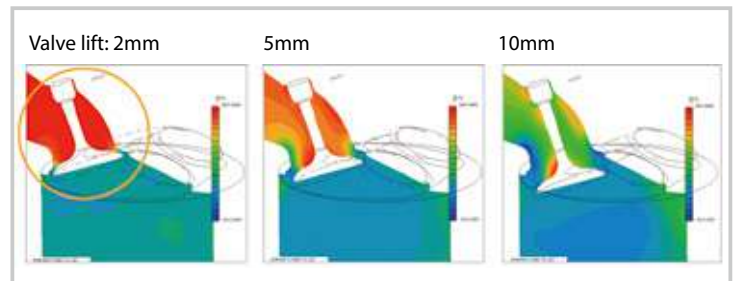

Figure. Example of comparison between analysis cases
Comparison of pressure at an intake port with different engine valve lift

Where does thermo-fluid analysis software come into play?

Thermo-fluid analysis software is indispensable for "Front-loading" product development to ensure the best product concepts that are identified early in the design process. Design quality will be improved during the conceptual design phase by conducting basic studies of fluid and thermal phenomena that directly affect product performance. During the detailed design phase, analyses are conducted under conditions similar to what the actual product will experience. From this work, design engineers can understand the source of problems that limit performance and investigate alternate design solutions before production begins.

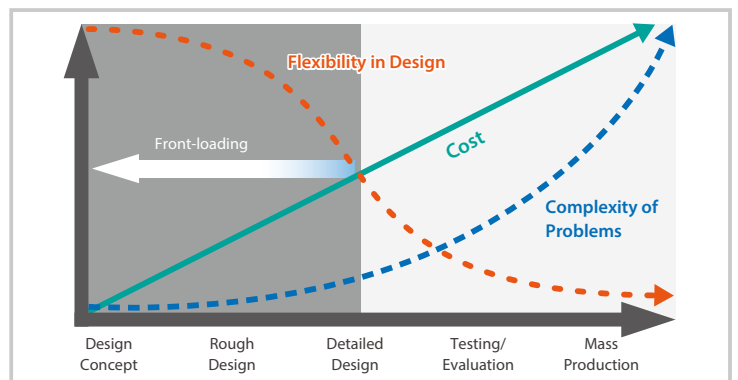

Figure. Product development process

Structured and unstructured mesh: the differences

Software Cradle offers two different types of thermo-fluid analysis tools: scSTREAM and HeatDesigner with structured mesh, scFLOW and SC/Tetra with unstructured mesh.

Structured mesh is simple and easy to construct. Structured mesh is comprised of many small cuboids so it can only approximate curved or angled surfaces with stair-case patterns. It is most useful for applications where tiny details and surface curvature or angles do not have a strong effect on the overall results. Examples of applications for structured mesh include electronics cooling, HVAC, and architecture.

Unstructured mesh is created using polyhedral elements. Mesh is generated such that it fits along the ridge lines of the original geometry. As a result, unstructured mesh is used for applications where precise representation of geometry is crucial. Examples of applications for unstructured mesh include vehicle aerodynamics, fan blade designs, and flows inside ducts.

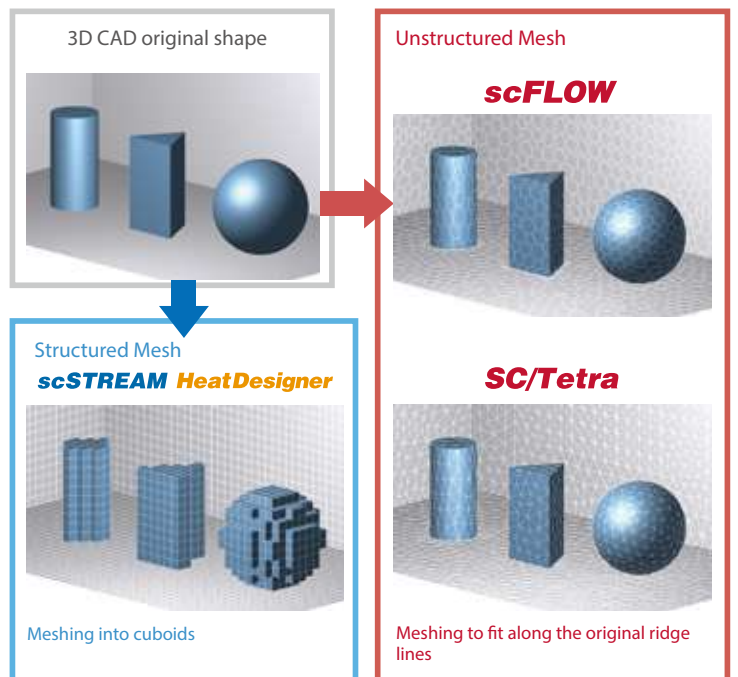
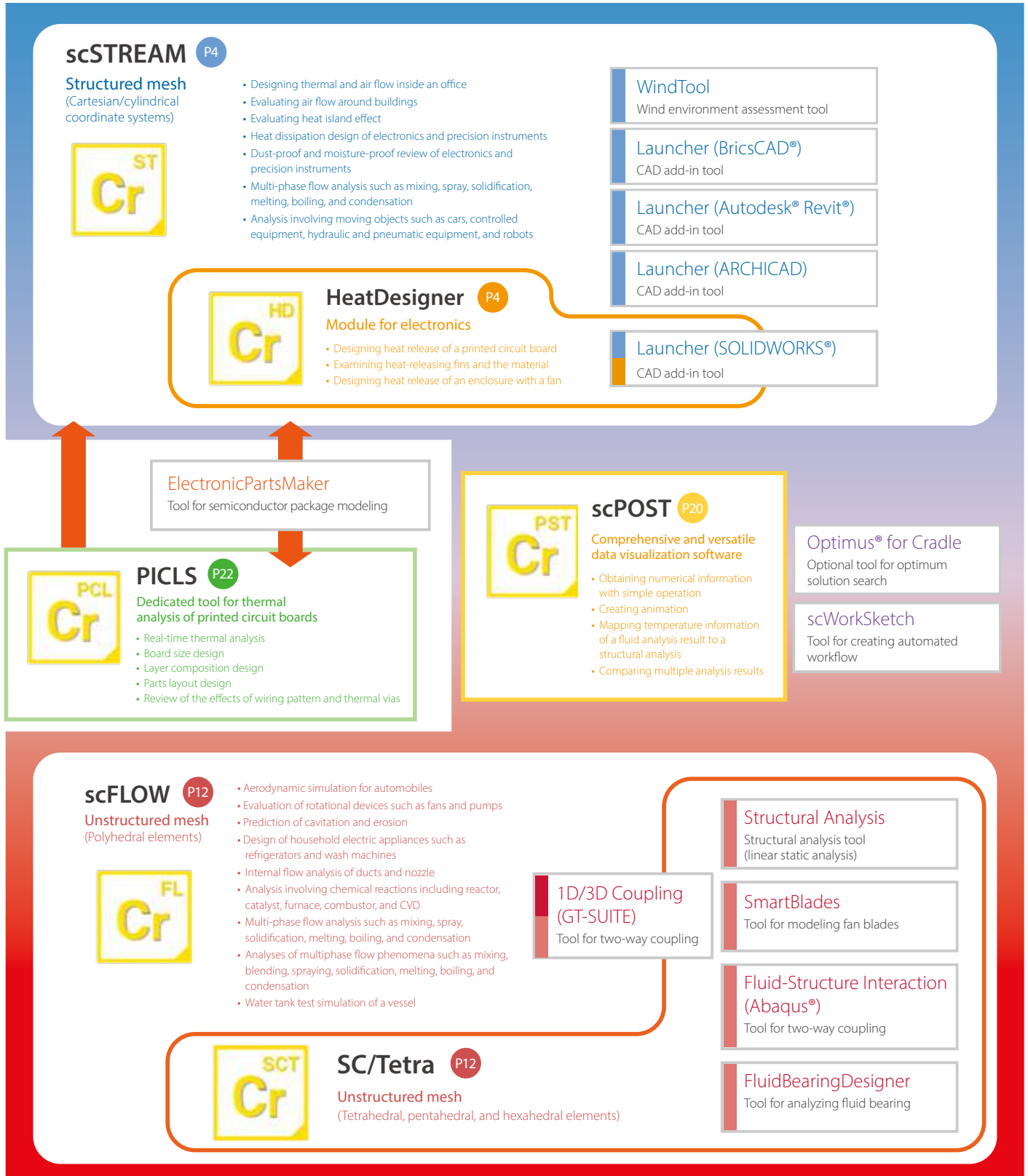

Figure. Differences between meshing methods

Products

Software Cradle develops and provides thermo-fluid simulation software and optional tools that suit various industries and objectives.

Thermo-fluid simulation software and main peripheral tools



Autodesk and Revit are registered trademarks of Autodesk, Inc. and/or its affiliates in the United States and other countries.
 ARCHICAD is a registered international trademark of GRAPHISOFT R&D Rt.

Is your analysis tool useful in years to come?

scSTREAM and HeatDesigner have proven track records for incorporating the latest leading edge technology

scSTREAM HeatDesigner

scSTREAM thermo-fluid software has serviced the electronics and architectural industries for more than thirty years. The ever-evolving software is characterized by its overwhelmingly user-friendly interfaces and high speed processing. HeatDesigner is based on scSTREAM and is specially developed for thermal design of electronics products. HeatDesigner provides physical functions required only for thermal design with its simple interfaces and powerful computing performance.

Various methods to represent shapes

ST

The shape of a model to be analyzed can be represented by using the following methods: voxel method (slanted faces and curved faces are represented in cuboids), cut-cell method (the shape of a model created with a CAD tool can be represented more accurately), and finite element model method (a model of an arbitrary shape defined with unstructured mesh can be overlapped on a model defined with structured mesh to use the shape created with a CAD tool as is).

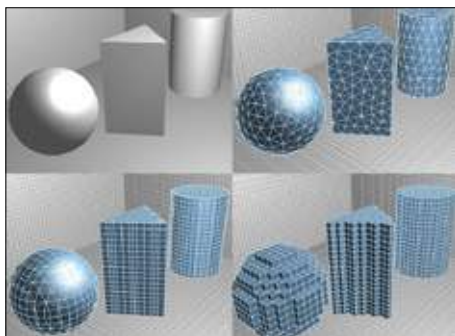

Large-scale calculation

ST HD

In structured mesh, even a complicated model does not need to be modified almost at all and the shape or the scale of a model does not affect the difficulty of mesh generation. In addition, Solver performs a calculation at a high speed in parallel computing and achieves effective processing as the speed increases depending on the number of subdomains.

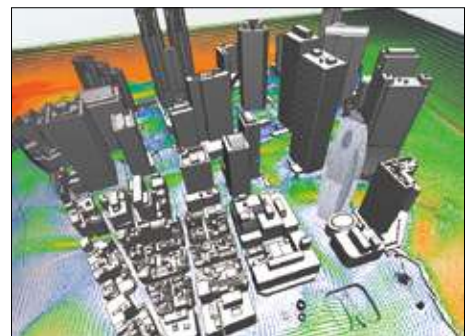

Moving objects

ST

A flow generated by a moving rigid object can be calculated. Conditions including the motions of an object (translation, rotation, and elastic deformation), heat generation/absorption, and air supply/return can be set. The model of a moving object is created on another mesh. In this way, conditions such as the distance that the object moves are limited very little.

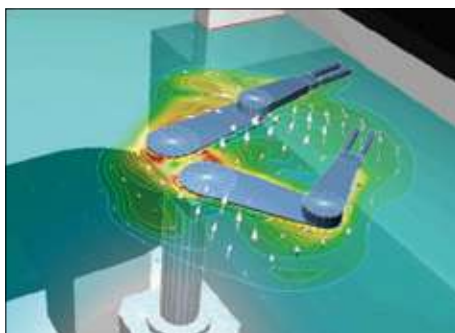

6-degree-of-freedom motion (6DOF)

ST

The function can analyze passive translation and rotation of an object receiving a fluid force. A moving object is assumed to be a rigid body. Its movement whose maximum degree of freedom is six (3D translation + 3D rotation) can be solved. The function can simulate driftwood which is flowed by a force from water flow.

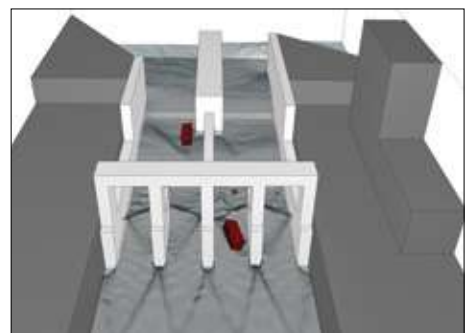

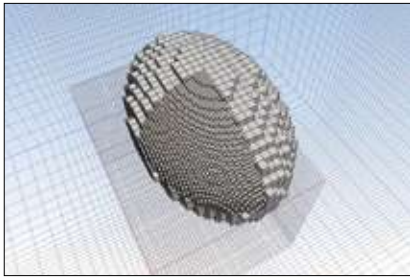

Multiblock

ST HD

Mesh can be refined partially to represent a model shape more accurately and perform a calculation more efficiently.

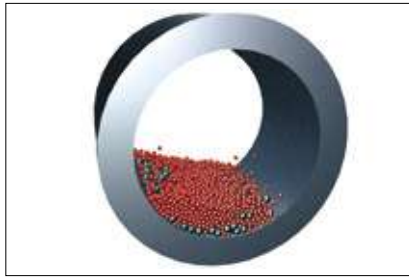

Discrete element method (DEM)

ST

Multiphase analyses can be performed, which enables coupling of fluid analysis and flow analysis of particles.



Parts library

ST HD

The shapes and conditions of frequently used parts can be registered. Conditions include the allocation position, material, and heat generation.

HeatPathView

ST HD

The information on temperature of each part and a comprehensive amount of heat release obtained in post-processing of a general CFD analysis is not enough to know the heat path. HeatPathView displays heat paths and the amount of heat transfer in the whole computational domain in a diagram, a graph, and a table, allowing you to find the bottleneck of the heat paths easily.



ElectronicPartsMaker

ST HD

The tool can create detailed models of semiconductor packages including QFP, SOP, and BGA by specifying parameters, and simplified models using thermal resistor models such as DELPHI models and two-resistor models. Manufacturers of semiconductor packages can provide the data of semiconductor packages as thermal resistor models without releasing the inside information.

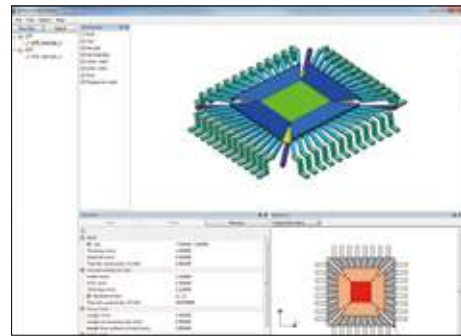

Reading wiring patterns

ST HD

To calculate heat transfer conditions depending on wiring patterns of a printed circuit board (PCB) in detail, the module can read Gerber data output from an electric CAD tool and import the data as a model for a thermo-fluid analysis. By using Gerber data, a more realistic calculation result can be obtained with the consideration of heat transfer affected by an uneven wiring pattern.

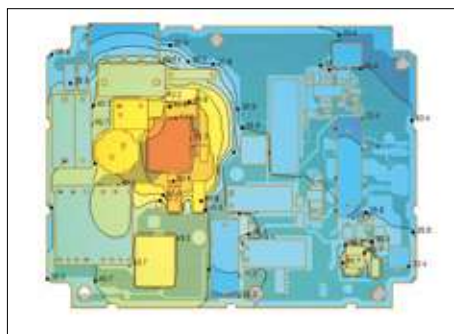

Radiation

ST HD

Radiation heat transfer with the consideration of diffusion, reflection, transmission, refraction, and absorption can be calculated. VF (view factor) method and FLUX method^{*1} can be used. The lamp function can simulate radiant heat by a filament without detailed shape information of a lamp. In addition to the filament, laser beam and defective radiation specified by half-value angle can be used as a heat source model.

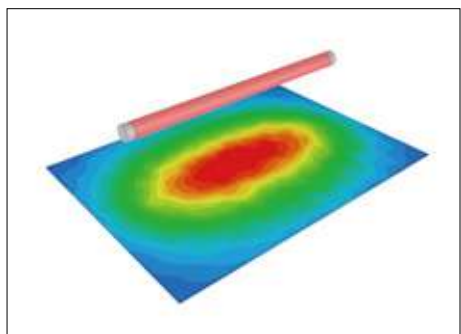

*1 Only for scSTREAM

Using structure function from measurement

ST HD

Modeling of electronic device is possible by converting result data of heat change over time used for transient heat resistance measurement¹ into structure function (thermal resistance - heat capacity characteristics). Accurate thermal model can be generated by comparing test and analysis data on the basis of structure function.

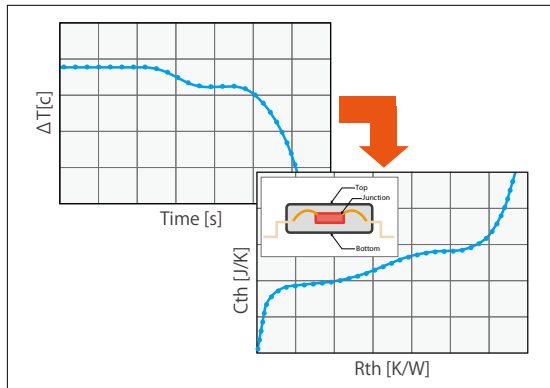

¹ Measurement device is not included

Electronic part model

ST HD

A wide range of models are available that enable to easily achieve thermal design of printed circuit boards and electrical enclosures, which includes DELPHI (multi-resistor) model, Peltier device and heat pipes. It is possible to consider pressure loss characteristics using slits, and P-Q characteristics of fans using swirling component. Generated models can be added in library.

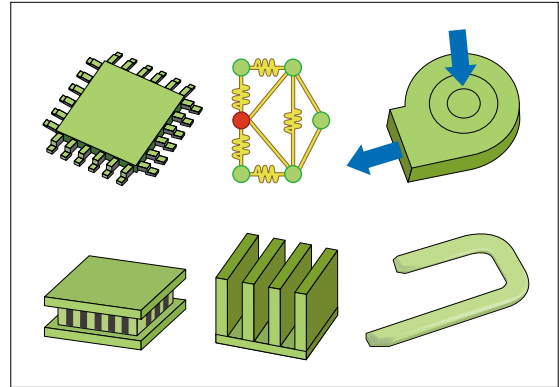

BIM

ST

The software interface supports BIM 2.0. Autodesk® Revit® and GRAPHISOFT ARCHICAD have a direct interface (optional) through which a target part can be selected and the tree structure can be kept and simplified. In addition, the module can load files in IFC format, which is the BIM-standard format.

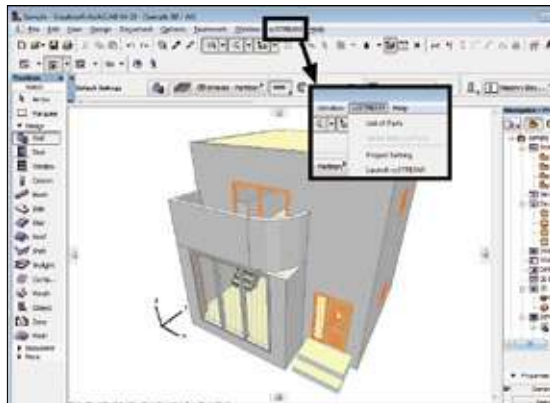

Illuminance analysis

ST

The software can calculate illuminance of various types of light; for example, daylight through an opening of a building and artificial lighting with consideration of its directivity. Object surfaces such as walls are treated as diffusive reflection surfaces. In general, the larger an opening of a building is, the larger heat loss tends to be. By calculating the illuminance, the balance between heat and light can be examined collectively.

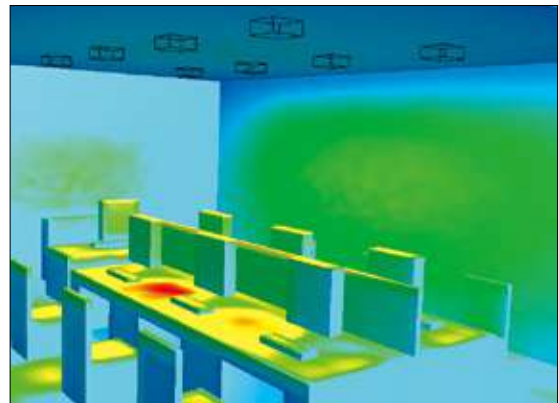

Air-conditioner parts (CFD parts) ST

The model shapes of parts frequently used for room air-conditioning can be imported. The models include ceiling cassettes, anemostat models, and linear diffusers. The software can import CFD part data, such as air supply characteristics, provided by SHASE. Various parameters can be set to simulate air-conditioning operation in addition to simple air heating and cooling.



*SHASE: Society of Heating, Air-Conditioning and Sanitary Engineers of Japan

Thermal comfort, heat stress risk and ventilation efficiency indices ST

Comfort indices PMV and SET* can be derived from already obtained temperature, humidity, and MRT (Mean Radiant Temperature), as one of result-processing functions. WBGT (heat stress risk indices), and the scale for ventilation efficiency (SVE), of which some indices can be converted to a real time, can be set by one click, and the range of calculation area can be selected (for example, either one of two rooms).

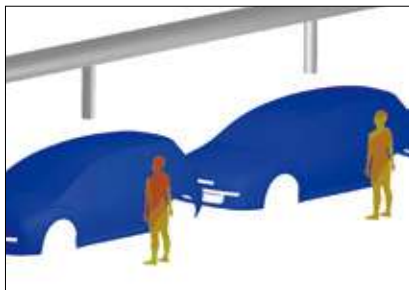

Plant canopy model (flow and heat) ST

Air resistance caused by plant canopy can be considered by setting the coefficient of friction and the leaf area density. For frequently used plants such as oak tree, their parameters are preset as the recommended values. The software also simulates the cooling effect by the latent heat of vaporization on a leaf surface by using the fixed temperature and setting the amount of absorbed heat. The function can be used for analyses of outdoor wind environment and heat island effect.

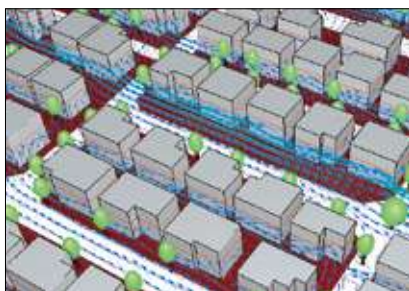

Solar radiation (ASHRAE, NEDO) ST

Climate data published by ASHRAE and NEDO is preset and can be used for condition setting. By entering arbitrary values of longitude, latitude, date, and time, the solar altitude and the azimuth angle of the sun at a specified location and time are calculated automatically. The effect of solar radiation can be examined in detail. Various parameters including absorption and reflectivity of solar radiation and materials which transmit light diffusely, such as frosted glass, can be set.

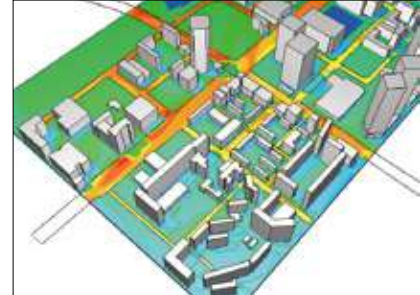

Humidity / dew condensation ST

The software can analyze humidity in the air. Dew condensation and evaporation on a wall surface due to temperature change can be considered and the amount of dew condensation and evaporation per time can be obtained. The software supports the analyses of moisture transfer inside a solid, and the function can be used to analyze a permeable object and dew condensation inside a part.

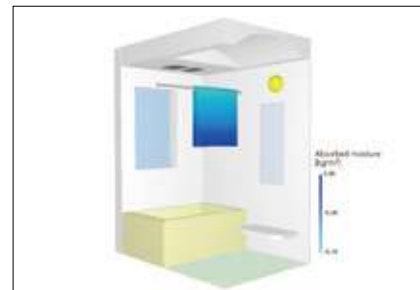

WindTool (outdoor wind environment assessment tool) ST

This tool helps assess outdoor wind environment. The assessment criteria can be selected from the ones proposed by Murakami et al. and by Wind Engineering Institute. By specifying a base shape and parameters required for wind environment evaluation, the parameters for 16 directions are calculated and the wind environment is ranked automatically. Detailed distributions of air current and pressure per direction can be visualized.

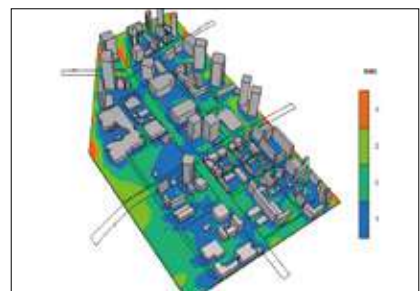

What is CAE?

scSTREAM | HeatDesigner

scFLOW | SC/Tetra

scPOST

Co-simulation with MSC Products

PICLS

Analysis Procedure

Main Mutual Features

Optimization Tool

License Type

Third-party Software

Electrostatic field

ST

In addition to fluid force, the effect of an electrostatic field, which applies external force to charged particles, can be considered. By setting electric charge of particles and electric potential of a wall surface, the function can be used for analyses to consider area control of electrostatic coating. Velocity at which charged particles do not adhere on a wall surface can also be examined by using the function.

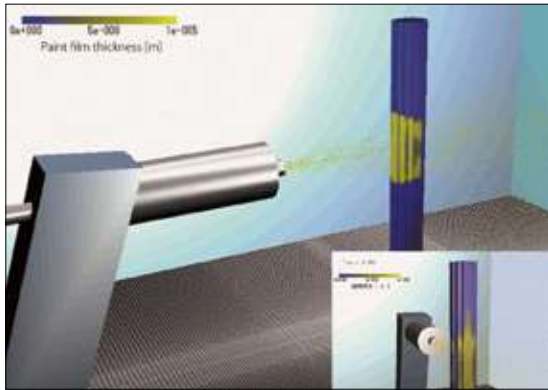

Mapping

ST

When a target phenomenon is in a small range and the phenomenon is affected by a wide range of its surrounding area, analysis results of the surrounding area can be used for an analysis of the target phenomenon as boundary conditions to decrease the calculation load. To analyze only the inside of an enclosure for an electronic device highly affected by its outside, the analysis results of the outside can be used as boundary conditions.

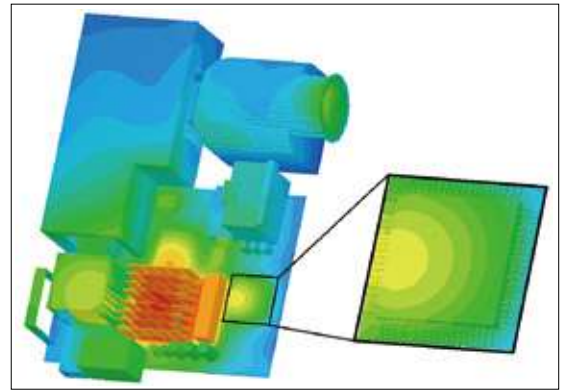

Flow of foaming resin

ST

The software calculates the behavior of filling up an object with foaming resin, which is used as a heat insulator for houses and refrigerators. To examine speed and pressure of filling-up and the position for injecting the resin, the software simulates the behavior in 3D. The simulation can provide more pieces of information in shorter time than an actual measurement.

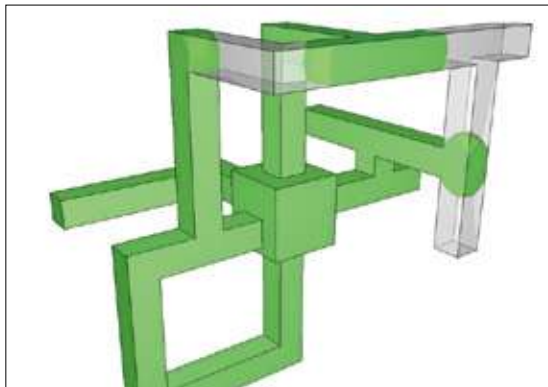

Free surface

ST

The software calculates the shape of an interface between a gas and a liquid. Either MARS or VOF method can be used, and the calculation target phase can be selected: both gas and liquid, only gas, or only liquid. The function is useful in a wide range of fields: from an analysis of tsunami in the civil engineering and construction field to an analysis of soldering in the electronic device field.

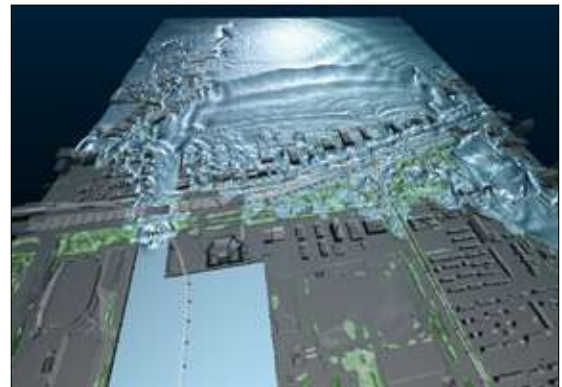

Solidification / melting

ST

The phase change between fluid and solid, for example, water to ice and ice to water, can be considered. The following phenomena related to solidification/melting can be considered: change of flow affected by a solidified region, change of melting speed depending on the flow status, and latent heat at melting. A phenomenon that water in an ice maker becomes ice can be simulated using the function.



Boiling / condensation (bubble nucleation, bubble growth / condensation)

ST

With the function, the user can analyze a boiling flow, which is a gas-liquid two-phase flow caused by temperature difference between a liquid and a heat conduction surface. A boiling flow is analyzed as a free surface analysis using MARS method, and latent heat generation and volume change due to bubble growth / condensation are considered using phase change model.

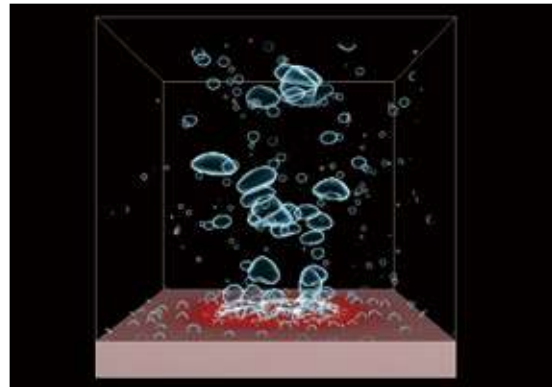

Particle tracking

ST

The software simulates the behavior of particles depending on their characteristics (diameter, density, and sedimentation speed) and action/reaction between particles and a fluid. This includes sedimentation due to gravity, inertial force for mass particles, and movement due to electrostatic force, liquefaction at adhering on a wall surface, evaporation and latent heat, the behavior as bubbles in a liquid for charged particles.

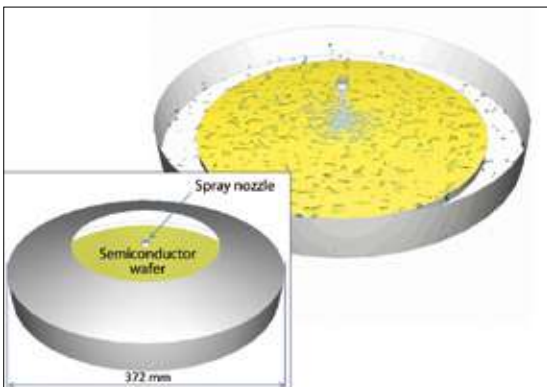

Panel (heat conduction / transfer* / thermal transport*)

ST HD

Material properties and motion conditions can be applied to a panel having no thickness in model, which allows for heat conduction to other parts and heat dissipation to air. This enables the simulations of paper feeding and film drying processes, where thin objects move and go under heating repetitively.

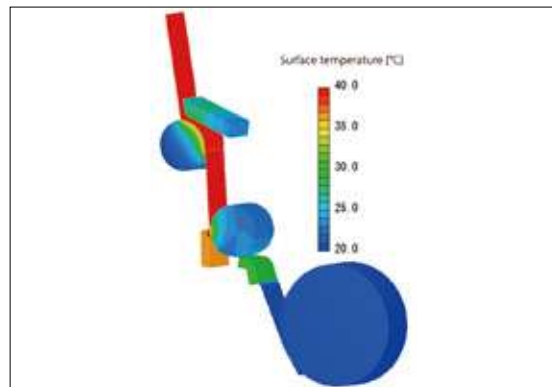

*Transfer and thermal transport are only available on scSTREAM

Functions (scSTREAM, HeatDesinger)

		scSTREAM	HeatDesigner	
Preprocessor	Modeling	CAD data Interface (import)	Parasolid, STEP, JT, STL, IGES, ACIS, CATIA V6, CATIA V5, CATIA V4, Creo Elements/Pro (Pro/Engineer), SOLIDWORKS, NX, Solid Edge, Inventor, DWG, DXF (2D, 3D-face), 3DM, VDAFS, XGL, IDF, Autodesk Revit, ARCHICAD, BricsCAD, Nastran, SHAPE, 3ds, SketchUp, IFC, PRE, MDL, NFB, Gerber (RS-274D, RS-274X), IPC-2581B	Parasolid, STEP, JT, STL, IGES, ACIS, CATIA V6, CATIA V5, CATIA V4, Creo Elements/Pro (Pro/Engineer), SOLIDWORKS, NX, Solid Edge, Inventor, DWG, DXF (2D, 3D-face), 3DM, VDAFS, XGL, IDF, MDL, NFB, Gerber (RS-274D, RS-274X), IPC-2581B
		CAD data interface (export)	Parasolid, STL, MDL, NFB	Parasolid, STL, MDL, NFB
	Primitives	Geometry modification	Cuboid, hexagon, cylinder, cone, sphere, revolved rectangle, point, panel (orthogonal, quadrilateral), 2.5D solid part, pipe components, fan (flat, axial, blower), electronics (including chassis, thermal circuit model) (two-resistor, DELPHI, multi-resistor), fin, slits, Peltier device, heat pipes, air-conditioning appliances (including 4 way cassette, 2 way cassette, wall type, floor type, outdoor unit, anemostat, linear diffuser)	Cuboid, hexagon, cylinder, cone, sphere, point, panel (orthogonal, quadrilateral), 2.5D solid part, pipe components, fan (flat, axial, blower), electronics (including chassis, thermal circuit model (two-resistor, DELPHI, multi-resistor), fin, slits, Peltier device, heat pipes)
		Registration of parts library	•	•
		Tetrahedron	• (finite element model)	•
	Mesh generation	Hexahedron	• (cylindrical coordinate system)	
		Cuboid	•	•
		Cut-cell	•	
	Conditions	Easy set-up through wizard	•	•
		Preset default conditions	•	•
		Unused dialogs hidden	•	•
		Collective settings to undefined regions	•	•
		Material property library (editable)	•	•
		Laminated materials	•	•
		Absorption-desorption property calculation	•	•
Operation and control environment	VB Interface	•	•	
	Selectable mouse operation modes	•	•	
	Mapping	•	•	
Solver	Mesh	Viewer mode	•	•
		Structured mesh	• (Cartesian or cylindrical coordinate)	• (Cartesian coordinate)
		Unstructured mesh	• (finite element model)	
	Numerical scheme	Multiblock	•	•
		Cut-cell	• (solid, panel, thin shape)	
		Moving objects	•	
	Flow types	6-degree-of-freedom motion (6DOF)	•	
		Finite volume method	•	•
		Pressure correction	SIMPLEC, SIMPLE	SIMPLEC
	Turbulence models	Convection term accuracy	1st / 3rd (QUICK / WENO) upwind scheme	1st / 3rd (QUICK / WENO) upwind scheme
		Matrix	MICCG, ILUCR, ILUCGS, FMGCG, FMGCGS	MICCG, ILUCR, ILUCGS, FMGCG, FMGCGS
		Non-linear coupled solver	• (JFNK method)	
	Thermal analysis	Steady-state / transient calculation	•	•
		Incompressible fluid	•	•
		Compressible fluid	•	
Diffusion analysis	Non-Newtonian fluid	•		
	Buoyancy (Boussinesq approximation)	•	•	
	Buoyancy (low-Mach-number approximation)	•		
Reaction analysis	Multiple fluids	•		
	Gas mixing	•		
	Foaming resin model	•		
Particle analysis	Standard k-ε model, RNG k-ε model, MP k-ε model, AKN linear low-Reynolds-number model, MPAKN linear low-Reynolds-number model, Non-linear low-Reynolds-number model, Improved LK k-ε model, Two-equation heat transfer (NK) model (high Reynolds number), Two-equation heat transfer (AKN) model (linear low-Reynolds-number), LES (Smagorinsky, Dynamic Smagorinsky, WALE, mixed-time scale)		Standard k-ε model, AKN linear low-Reynolds-number model	
	Heat conduction (fluid/solid)	•	•	
	Convective heat transfer	•	•	
Discrete element method (DEM)	Heat radiation (view factor method)	•	•	
	Heat radiation (flux method)	•	•	
	Heat conduction panel	•	•	
Multiphase flow analysis	Solar radiation	• (direct / sky solar radiation / reflection)		
	Lamp (graphic output of rays)	•		
	Joule heat	•		
Current analysis	Mean radiation temperature calculation	•		
	Global solar radiation calculation	•		
	Diffusivity	•		
Thermal comfort index	Sedimentation rate	•		
	SORET effect	•		
	Index for ventilation efficiency	Age of air, life expectancy of air, inlet contribution rate	•	
Illumination analysis	PMV / SET*/ WBGT	•		
	Solar radiation / lamp (graphic output of rays)	•		
	Relative humidity / absolute humidity	•		
Reaction analysis	Dew condensation	•		
	Humidity transfer in solid	•		
	Chemical reaction	•		
Particle analysis	Combustion	• Eddy-dissipation model, PDF (Probability Density Function) method		
	Marker particles	•		
	Mass particles	•		
Discrete element method (DEM)	Reactant particles	•		
	Charged particles	•		
	Spray model	•		
Multiphase flow analysis	Transforming dew condensation	•		
	Transforming fluid / volume rate	• (MARS method)		
	Contact model	Linear spring dashpot model, Hertz-Mindlin model, Walton-Braun model		
Current analysis	Cloth model	• (command input)		
	Cohesion model	•		
	Thermal	•		
Thermal circuit model	Ad/desorption (Humidity)	•		
	Free surface	• (VOF method, MARS method)		
	Solidification / melting	• (VOF method, MARS method)		
Thermo-regulation model	Boiling / condensation	• (MARS method)		
	Evaporation / condensation	• (MARS method)		
	Conductor current	•		
Optimization	Conductor potential	•		
	Braking effect of static magnetic field	•		
	Electrostatic field	•		
Flow conditions	2-resistor / DELPHI model / multi-resistor	•	•	
	JOS-2	•		
	Topology optimization	•		
Flow conditions	Velocity	•	•	
	Power-law velocity	•		
	Volume flow rate	•	•	
Flow conditions	Radial volume flow rate	•		
	Pressure (static, total)	•	•	
	Natural inflow / outflow	•	•	
Flow conditions	Air-conditioner model	•		
	Fan model	•	•	
	Wave generation, wave dissipation	• (MARS method)		

Functions (scSTREAM, HeatDesigner)

			scSTREAM	HeatDesigner
Solver	Thermal conditions	Fixed temperature	•	•
		Heat source	•	•
		Heat transfer coefficient	•	•
		Contact heat transfer coefficient	•	•
	Wall conditions	No-slip (stationary wall)	•	•
		Free-slip (symmetry wall)	•	•
		Log-law condition	•	•
		Power-law condition	•	•
		Surface roughness	•	•
	Pressure conditions	Wall model (LES)	•	•
		Fixed pressure	•	•
		Pressure loss	•	•
	Source conditions	Porous media	•	•
		Volume force / pressure loss	•	•
Heat source		•	•	
Smoke source (diffusing materials)		•	•	
Turbulence generation		•	•	
User-defined conditions	Humidification	•	•	
	Plant canopy	•	•	
	Variables table / functions	•	•	
Calculation control environment	Scripts (JavaScript)	•	•	
	User-defined function (compilation required)	•	•	
	Job management	•	•	
Output post files	Monitoring the calculation status	•	•	
	Email notification of the calculation	•	•	
Output for third party software	VB interface	•	•	
		Software Cradle post files (FLD, iFLD)	Software Cradle post files (FLD, iFLD)	
Output for third party software		Abaqus, Nastran, Femtet, ADVENTURECluster, JMAG-Designer, EMSolution, Optimus, Isight, modeFRONTIER, Autodesk Revit, ARCHICAD, ThermoRender, EnSight, FieldView, Adams, Marc	Abaqus, Nastran, Femtet, ADVENTURECluster, JMAG-Designer, EMSolution, Optimus, Isight, modeFRONTIER, EnSight, FieldView	
Postprocessor	Drawing functions	Mesh, vector, contour plots	•	•
		Isosurface, streamline, pathline, volume rendering	•	•
		Geometry display	• (STL file, NFB file, Wavefront OBJ file)	•
		2D graph	•	•
	Drawing position / orientation	Mirror / periodical copy	•	•
		Vortex center	•	•
		Arbitrary plane, surface, entire volume, cylinder	•	•
		Streamlines, isosurface	•	•
	Special effects	Pathlines	•	•
		Arbitrary scaling	•	•
		Arbitrary pick	• (scalar / vector value)	• (on plane / surface)
		Oil flow	• (on plane / surface, arbitrary geometry with texture)	• (preset, arbitrary)
	Animation	Texture mapping	•	•
		Lighting, luster, gradation	•	•
		Transparency, water-like expression, shadow	•	•
		Ray, Cloth, Surface of particles, Road line, Road line, Heat transfer, IPC-2581	•	•
	Analysis results	Photorealistic	•	•
		Vector animation	•	•
		Flow line animation	•	•
		Cut-plane sweeping	•	•
	Data image output	Marker particle	• (turbulent diffusion effect)	• (view / focus points can be set)
		Automatic translation of view point	•	•
		Key-frame animation, Time line	•	•
		Animation interpolated between cycles	•	•
	Operation and control environment	Variable registration	•	•
		Integral (surface / volume)	• (scalar / vector integration)	• (clipping function, image compare)
		Comparison	•	•
		Projected area calculation	•	•
Operation and control environment	Automatic search of the local max / min positions	•	•	
	Import of CSV data	•	•	
	Automatic change of colorbar	• (preset, arbitrary)	•	
	Complex values data graphing	•	•	
Operation and control environment	Microsoft BMP, JPEG, PNG	• (size, resolution adjustable)	• (support steady-state / transient animation, attach to Office applications)	
	CradleViewer	•	•	
	AVI, WMV, MP4	•	•	
	VRLM, FBX, STL	•	•	
Operation and control environment	Copy & paste 3D onto Powerpoint	•	•	
	Selectable help function	•	•	
	OpenGL emulation (Hardware acceleration, software rendering)	•	•	
	VB interface	•	•	
Operation and control environment	Selectable mouse operation modes	•	•	
	Stereoscopic view (side by side)	•	•	
	Plug-in functionality	•	•	
	Partial open field file by SSH	•	•	

System Configuration

Product	Compliant OS	CPU, Memory, HDD	Graphics	Approx. size of analysis	Compiler Environment (User defined function)	MPI Library
scSTREAM HeatDesigner	Windows	[CPU] 64bit(AMD64/Intel64) [Memory] 8GB or more ; depends on the number of elements [HDD] 10GB for installation	[Graphics] Graphics card that supports OpenGL for Preprocessor/Postprocessor	[Memory] Approx. 10 million elements/5.5GB [Maximum number of elements] 2 billion [Maximum degree of parallelism (actual)] 36864 ³	[Windows edition] Intel Parallel Studio XE 2018 Composer Edition for Fortran Intel Parallel Studio XE 2019 Composer Edition for Fortran [Linux edition] GFortran (GNU Fortran compiler) (Linux standard)	Intel® MPI Library 2018 Update 5 or 2019 Update 10 (Windows), Update 11 (Linux) ²
	Linux ¹	RedHat Enterprise Linux 7 (Verified by 7.9) RedHat Enterprise Linux 8 (Verified by 8.4) SUSE Linux Enterprise Server 12 (Verified by SP4) SUSE Linux Enterprise Server 15 (Verified by SP1, SP2)				

Windows is a registered trademark of Microsoft Corporation in the United States and other countries.
 The official name of Windows is the "Microsoft® Windows® Operating System".
 Microsoft Visual Studio is a registered trademark of Microsoft Corporation in the United States and other countries.
 Linux is a trademark registered to Linus Torvalds in the United States and other countries.
 Intel is a registered trademark of Intel Corporation in the United States and other countries.
 Red Hat is a registered trademark of Red Hat, Inc. in the United States and other countries.
 SUSE is a registered trademark of SUSE LLC.
 All other product and service names mentioned are registered trademarks or trademarks of their respective companies.

¹ Only compliant with Solver and Monitor. Not available for HeatDesigner.
² Use Intel-MPI packaged in Cradle products. When activating on multiple machines, we recommend you use it under the environment that meets the Intel® MPI Library system requirements.
³ Actual record with parallelism in a subdomain. (Upper limit of the number of subdomains is 4096.)

What is CAE?

scSTREAM | HeatDesigner

scFLOW / SC/Tetra

scPOST

Co-simulation with MSC Products

PICLS

Analysis Procedure

Main Mutual Features

Optimization Tool

License Type

Third-party Software

The ever-evolving latest CFD solution

Discover what you want from your CFD tool here

scFLOW SC/Tetra

SC/Tetra has been characterized by sophisticated mesh generation function, high speed computing capability, and user-friendly features throughout the operation. As its advanced version, scFLOW has been released. It is equipped with more stable Solver that achieves calculation speed three times faster (at maximum) than before, and new Preprocessor that helps entry-level users build complicated models and high-quality mesh. scFLOW, the new generation software, keeps on evolving.

Simplification of Preprocessor operations

FLOW

From the CAD data to analysis mesh data, the required operations are grossly simplified compared to before. The conservation of assembly information and the settings of conditions on the parts bring the sense of continuity from the CAD operations and reduce the operational burden of the users.

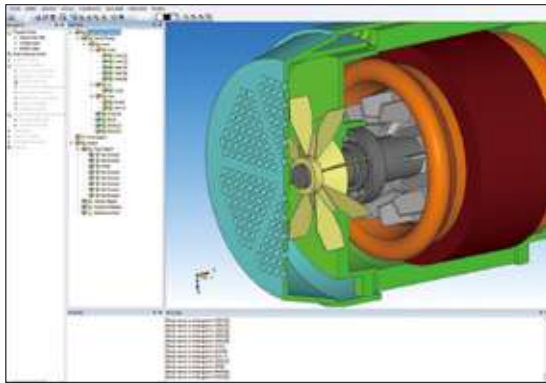

Polyhedral mesher

FLOW

Using polyhedral mesh elements improves stability and calculation accuracy of cell-centered solver. In scFLOWpre, mesh can be generated according to the target number of mesh elements and automatically refined near wall area. The automatic mesher function also enables users to specify mesh refinement level of each part and region.

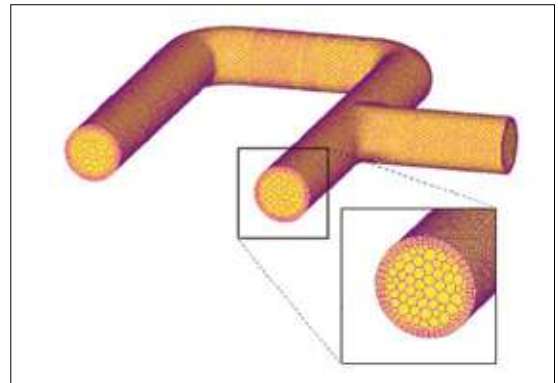

Modifying CAD data

FLOW SCT

When CAD data to be used for simulation has a problem, the data can be modified with Preprocessor. Boundary conditions can be set based on the part names and color information set in the CAD data. When some regions are missing in the model, shapes such as cuboids and cylinders can be added.

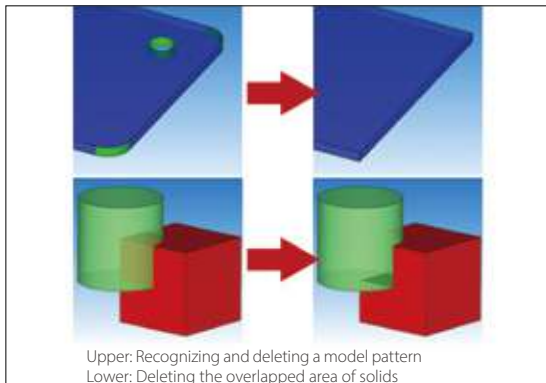

Viewer mode

FLOW

Preprocessor data can be displayed in the viewer mode without the Pre-/Post-processor license, when the license is taken by the mesher or by Postprocessor and is unavailable.

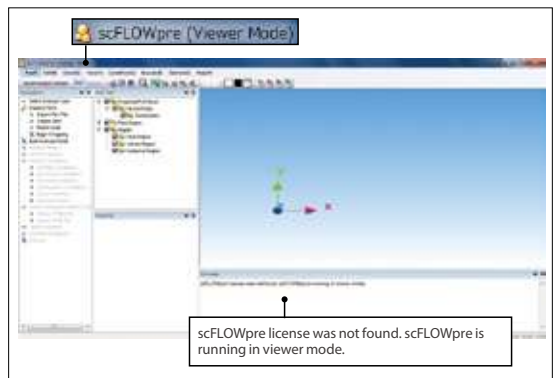

Mesh-adaptation analysis **FLOW** **SCT**

With this function, mesh will be automatically refined where a flow or pressure changes greatly in a steady-state analysis. After the calculation in Solver is completed, Preprocessor automatically launches and executes gridding and meshing based on the calculation result. By specifying the target number of elements, coarse mesh is generated first and the mesh is automatically refined to be appropriate for the calculation. The function is useful for an analysis of flows in a tube with a complicated shape.

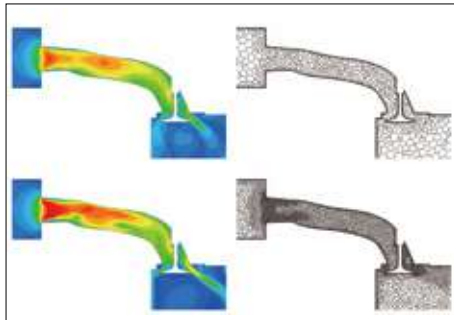

Stabilization of calculation **FLOW**

Even for mesh data with elements of extremely low quality, the calculation can be stabilized by the automatic processing to avoid divergence. This function helps Solver be more robust.

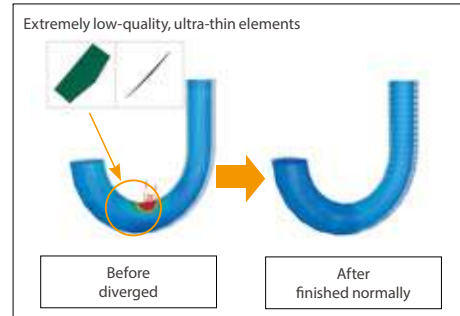

Discontinuous mesh **FLOW** **SCT**

Flow with object motion can be calculated, including rotation of fans and turbines, and crossing travel of automobiles or trains (translation). The function enables an analysis with consideration on shear heating between rotor and pad in a disk brake. The function also makes it possible to analyze a combination of rotation and translation such as a piston pump.

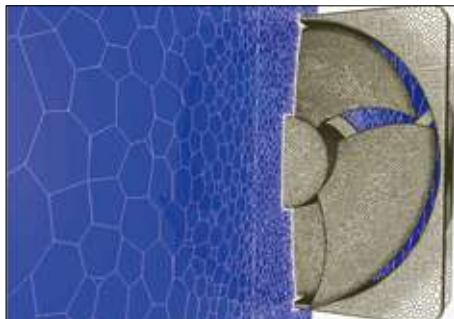

Overset mesh **FLOW** **SCT**

Free movement of regions, that cannot be analyzed using existing functions such as stretching or rotating elements, can now be simulated by overlapping mesh elements for stationary and moving regions. This function supports an overlap of multiple moving regions, a contact between objects, and a 6-degree-of-freedom motion of rigid bodies. This is useful to analyze opening and closing of a valve of an engine port or a gear pump where gears engage with each other.

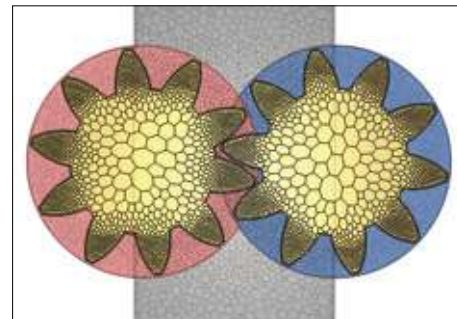

Free surface (steady-state / transient) **FLOW** **SCT**

The shape of an interface between a gas and a liquid can be simulated. Calculations by VOF method (new method: FIRM) are fast and accurate, and functions including moving boundary, overset mesh, and particle tracking can be used in combination. Because a phenomenon where the phase interface becomes stable can be analyzed in a steady-state calculation, the result can be obtained in a shorter time than before.



* Only scFLOW supports FIRM. FIRM cannot be used for overset mesh or steady-state analyses.

6-degree-of-freedom motion (6DOF) **FLOW** **SCT**

Passive translation and rotation of a rigid body receiving a fluid force can be analyzed. With the function, the user can analyze a ball valve with consideration of the elasticity of the spring (1D translation), and paper airplane with consideration of 6-degree-of-freedom rigid-body motion (3D translation + 3D rotation). In addition, the function is applied to analyses of check valves, wind power generators, and blades of wave power generators.

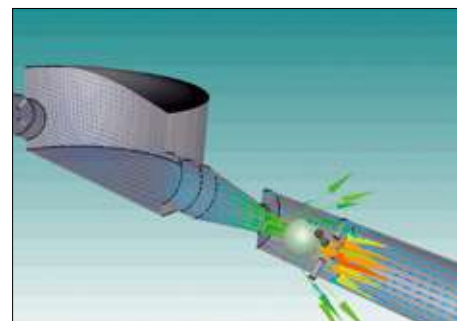

What is CAE?

scSTREAM | HeatDesigner

scFLOW | SC/Tetra

scPOST

Co-simulation with MSC Products

PICLS

Analysis Procedure

Main Mutual Features

Optimization Tool

License Type

Third-party Software

Cavitation

FLOW SCT

This function enables simulation of a vaporization phenomenon called cavitation, which is caused at an area where pressure of a liquid becomes lower than in the surrounding area, such as with a propeller rotating at a high speed under water. The occurrence of cavitation can be predicted by applying the cavitation model based on the pressure values. The software also supports problems caused by cavitation such as erosion.



Fluid-structure interaction

FLOW SCT

This option is used for two-way FSI (fluid-structure interaction) with structural analysis software. With this option, not only rigid bodies but also elastic bodies can be treated. Deformation of an object caused by a fluid force and the change of fluid caused by the deformation can be analyzed.

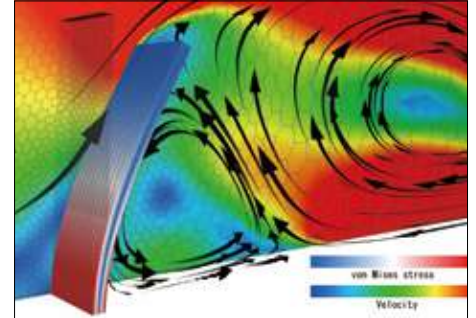

Compressible fluid

FLOW SCT

The software can analyze phenomena such as supersonic flow and significant expansion/contraction of volume. For a compressible fluid, both the pressure-based and the density-based Solvers can be used. The density-based Solver keeps the calculation stable even with high Mach number. You can select either Solver depending on the analysis target and phenomenon.

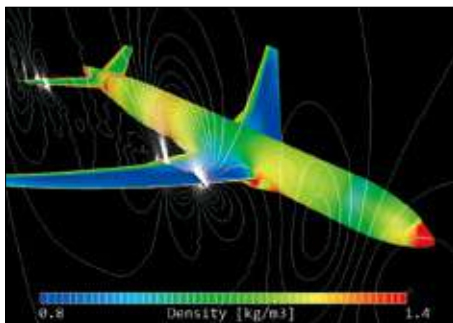

Aerodynamic noise analysis

FLOW SCT

Sound caused by pressure oscillation of a fluid, such as wind noise, and sound caused by resonance can be predicted. The calculation can be performed accurately by using LES and the weak compressible flow model. The frequency of aerodynamic noise can also be analyzed using the Fast Fourier Transform (FFT) method from the CFD analysis result.

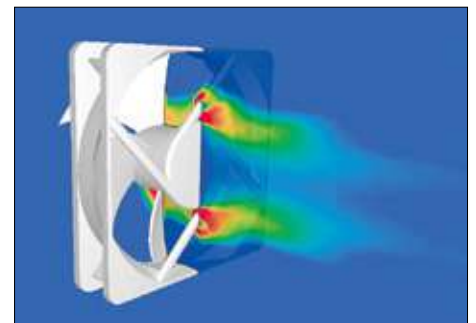

Evaporation/Condensation

FLOW

Free surface analysis function (VOF method) of this software can simulate phase change between gas and liquid, such as evaporation and condensation. By considering phase change, not only simple heat conduction but also heat transfer from latent heat can be calculated. For example, this method can be applied to internal flow simulations for heat transfer devices such as heat pipes, in which a refrigerant liquid changes to vapor by absorbing heat from an outer region.

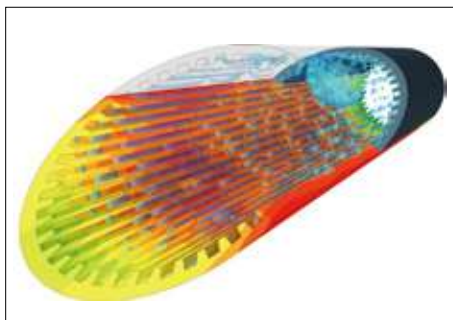

Dispersed multi-phase flow

FLOW SCT

This function can simulate flows containing many bubbles, droplets, or particles (dispersed phase), which are difficult to be analyzed using free surface. This function is a multi-fluid model that can predict volume fraction distribution and velocity distribution of each phase by solving the governing equation under the assumption that the dispersed phase is a fluid (continuous phase). The function is useful to analyze the bubble jet effect and aeration tanks.

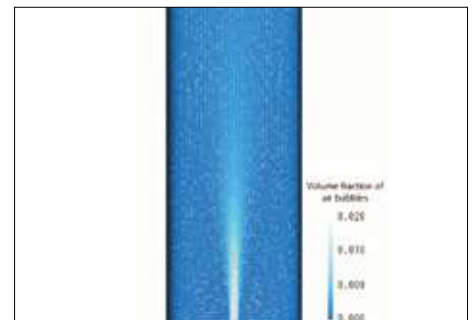

Particle tracking

FLOW SCT

Particle tracking function enables analyzing behavior of particles in flow. When analyzing small particles that follow the fluids movement (such as steam and dust), marker particle function can be used to evaluate particles in flow that change over time, which assumes that particle movement is in accordance with fluid velocity.

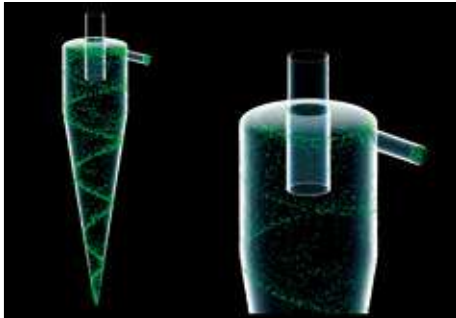

Humidity dew condensation

FLOW SCT

The amount of dew condensation on an object surface can be calculated from the surface temperature and water vapor in the air. You can output the amount of dew condensation per unit time in a steady-state analysis and the accumulated dew condensation in a transient analysis. Evaporation from a surface where dew condensation occurs can be calculated simultaneously, and this is useful for an analysis of a windshield defroster.

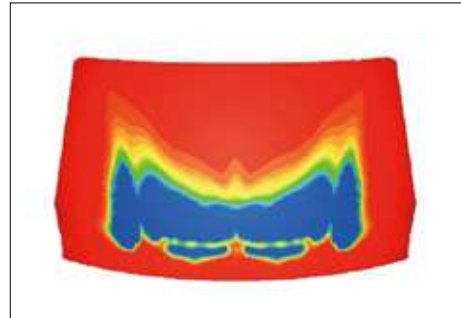

Liquid film model

FLOW SCT

The liquid film model is an extended function of the particle tracking function. By using the model, you the user can simulate the phenomenon that liquid particles change to a liquid film (water on a wall) when they reaching on the a wall. A liquid film on a wall flows with the influence of gravity and a gas-phase flowdown depending on an angle of the wall and collects in at a certain position.

The analysis results are output as the thickness of a liquid film.

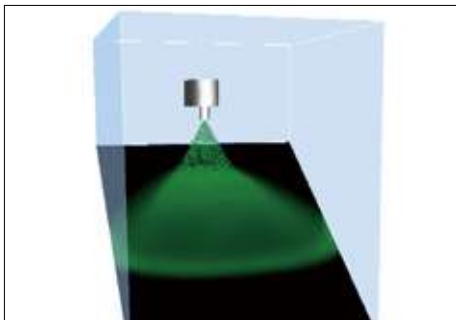

Thermoregulation-model (JOS)

FLOW SCT

Combination use of the thermoregulation-model (JOS) and a fluid analysis enables analyses of the surface temperature of a human body under a certain thermal environment. It can also be used to analyze temperature and humidity changes in the surrounding environment of a human body. The user can consider age, clothes, and physiological phenomena of the human body such as heat transfer by blood flow in addition to the surrounding environment of a human body such as temperature and velocity.

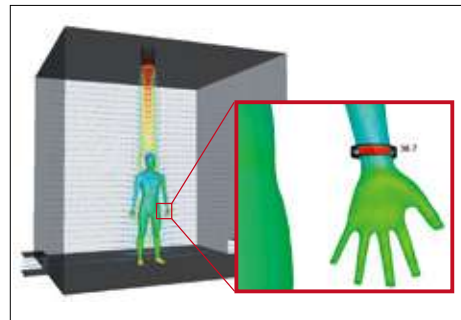

*JOS and JOS-2 developed by Tanabe laboratory at Waseda University, et al. are introduced for the thermoregulation model.

LES

FLOW SCT

LES is one of the turbulent flow models. It models eddies smaller than the mesh element in size and directly calculates other eddies. Although calculation load is large, LES enables simulations closer to real phenomena. LES is often used in noise analyses, significantly affected by time variation, to simulate the behavior of small eddies. The user can use the hybrid model with RANS, a turbulent model of small calculation load.

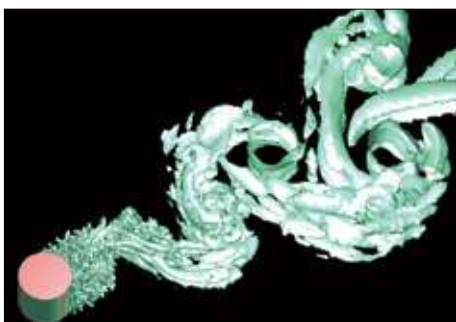

Radiation

FLOW SCT

Heat transfer by infrared-ray radiation can be considered by setting emissivity and temperature difference between objects. The user can choose VF (view factor) method or FLUX method as a calculation method. The user can also consider wavelength dependence, transmission, absorption, refraction, diffusion, and reflection of radiation. In FLUX method, the user can also consider directionality.

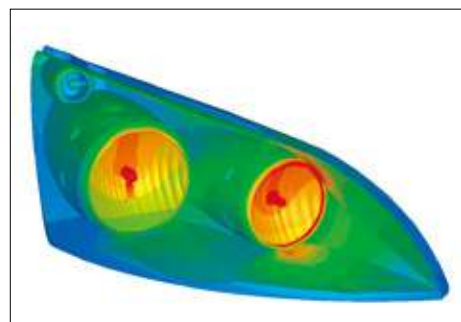

Mapping

FLOW SCT

When a target phenomenon is in a small range and the phenomenon is affected by a wide range of its surrounding area, analysis results of the surrounding area can be used for an analysis of the target phenomenon as boundary conditions to decrease the calculation load.

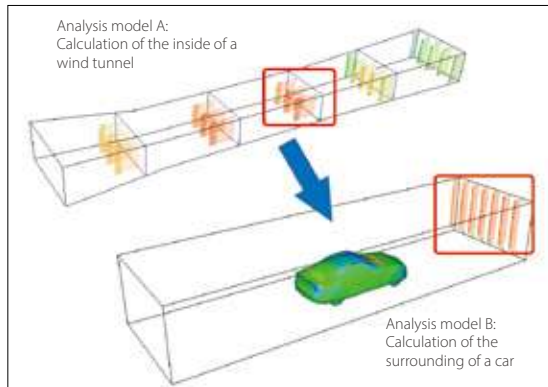

Fan model (rotating blades)

FLOW SCT

With this model, an average flow field around rotating blades can be simulated only by entering characteristic properties regardless of real shapes of fans or propellers. The user can use the non-dimensional swirl coefficient model, the simplified propeller model, and the simplified rotor model. This model is useful to analyze axial-flow windmills and waterwheels.

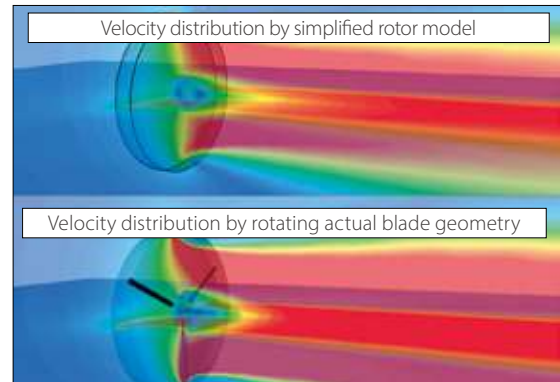

Operation logging by VB interface

FLOW

The operations in Preprocessor can be saved as a log file using the VB interface. Making the user scripting unnecessary, this makes the construction of an automated system affordable in a short period of time based on the files storing the operation logs.

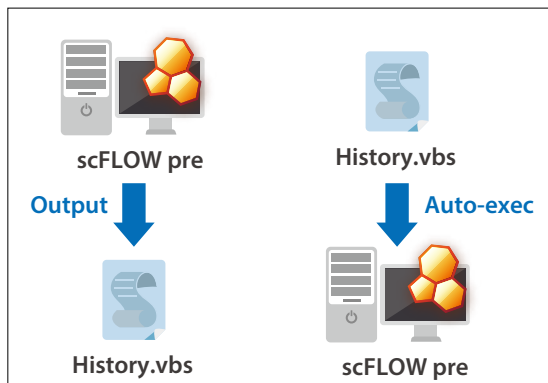

Coupled analysis with GT-SUITE

FLOW SCT

Coupled analysis with GT-SUITE is available. The entire flow in an intake and exhaust system is calculated with GT-SUITE and small flows of each part are interpolated with scFLOW or SC/Tetra. This will enhance calculation accuracy of the whole system.

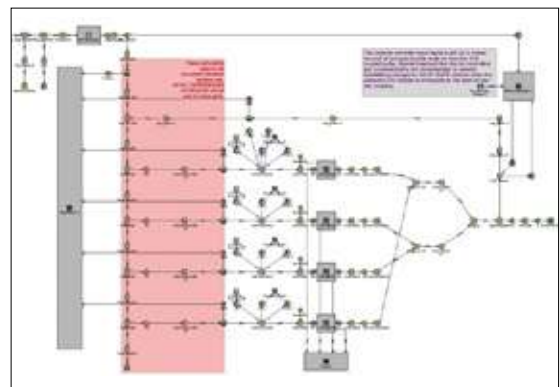

*GT-SUITE is engine intake & exhaust system one-dimensional thermo-fluid analysis software provided by Gamma Technology

Script functions

FLOW

Before, complicated settings, including time-/coordinate-dependent material properties or boundary conditions, required a coding and compilation of user-defined function in C language. With the script functions, compilation is not required. Functions can be written in Preprocessor based on JavaScript.

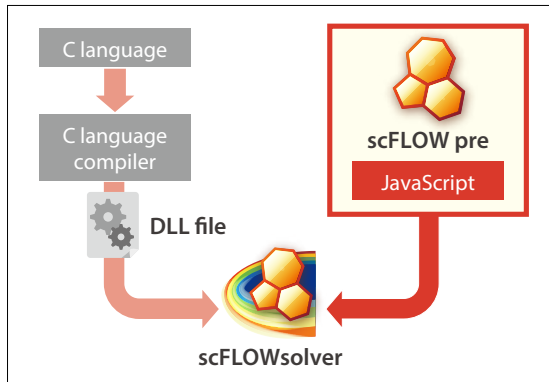

SmartBlades

FLOW SCT

This function is useful for analyzing the shape of a fan automatically throughout creating the shape of a fan (CAD data), calculating the flow, and post-processing. The shape of a fan can be created easily by specifying parameters including the number of blades, fan diameter, rake angle, and skew angle.

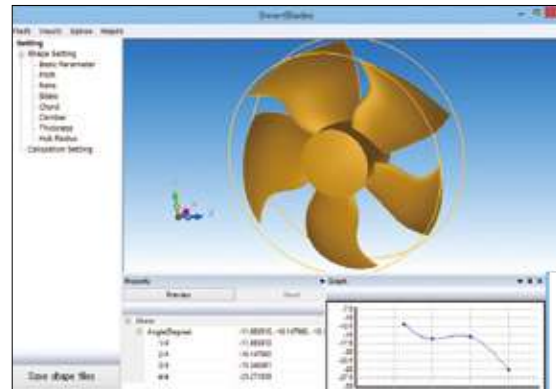

Functions for turbomachinery

SCT

One-pitch shape can be extracted from a periodic model such as an impeller or a vane of turbomachinery. The analysis result of the one-pitch model can be checked in the meridian plane. Two regions whose pitches are different can also be analyzed. The calculation load will be reduced by using this function.

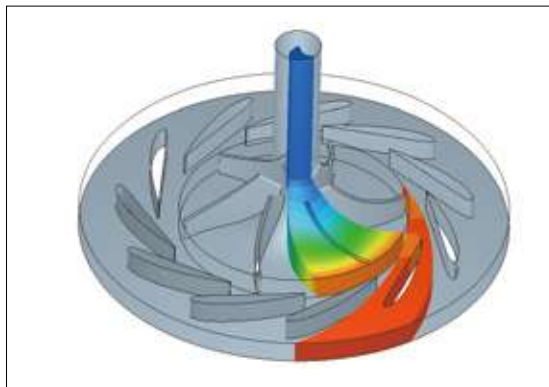

FluidBearingDesigner

SCT

The function creates groove patterns of fluid bearings (dynamic-pressure bearing) and generates mesh. You can select the shape of grooves such as journal and thrust and materials such as porous material. From calculation results, you can obtain parameters for designing fluid bearings such as axial force and drag coefficient.

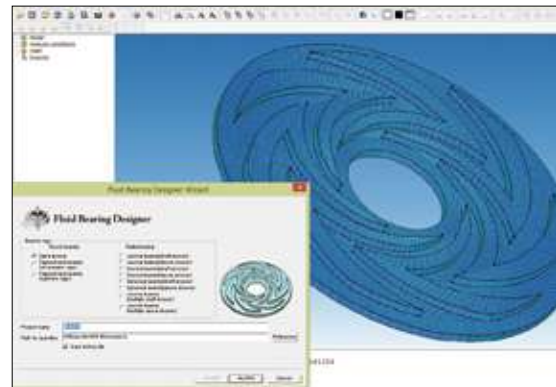

Functions (scFLOW, SC/Tetra)

			scFLOW	SC/Tetra	
Preprocessor	Modeling	CAD data Interface (import)	Parasolid, STEP, JT, STL, IGES, ACIS, CATIA V6, CATIA V5, CATIA V4, Creo Elements/Pro (Pro/Engineer), SOLIDWORKS, NX, Solid Edge, Inventor, DWG, DXF (3D-face), 3DM, VDAFS, IFC, Nastran, MDL	Parasolid, STEP, STL, IGES, ACIS, CATIA V5, CATIA V4, Creo Elements/Pro (Pro/Engineer), SOLIDWORKS, NX, Solid Edge, Inventor, DXF (3D-face), VDAFS, Abaqus, Nastran, Design Space, Plot3D, CGNS	
		CAD data interface (export)	Parasolid, MDL	STL, Nastran, CGNS, Parasolid, MDL	
		Primitives	Cuboid, cylinder, sphere	Cuboid, cylinder, sphere, rectangle (panel)	
		Geometry modification	Data cleaning, editing solid, editing sheet, cross-section and extraction, coordinate conversion, wrapping	Data cleaning, editing solid, editing sheet, cross-section and extraction, coordinate conversion, turbomachinery (single-pitch extraction), wrapping	
	Mesh generation and faceter	Tetrahedron		•	•
		Pentahedron (prism, pyramid)			•
		Hexahedron			• (manual setting)
		Cuboid	• (when internal hexahedron elements are used)		• (when internal hexahedron elements are used)
		Polygon (polyhedron)	•		
		Sweep mesh	•		•
		Thin mesh	•		
		Voxel fitting mesher	•		
	Conditions	Solid-based surface mesher	•		
		Parasolid faceter	•		•
		Solid-based faceter	•		
Easy set-up through wizard		•		•	
Unused dialogs hidden		•		•	
Operation and control environment	Collective settings to undefined regions	•		•	
	Material property library (editable)	•		•	
	Laminated materials			• (laminated panel)	
VB Interface	•		•		
Selectable mouse operation modes	•		•		
Mapping	•		•		
Viewer mode	•		•		
Mesh	Unstructured mesh	•		•	
	Overset mesh	•		•	
	Mesh adaptation	•		•	
	Mesh adaptation in solver	•		•	
	Discontinuous mesh interface	•		•	
	ALE (rotation, translation, stretch)	•		•	
	6-degree-of-freedom motion (6DOF)	•		•	
	Mixing plane	•		•	
Numerical scheme	Finite volume method				
	Pressure correction	SIMPLEC, SIMPLE, PISO		SIMPLEC, SIMPLE, revised SIMPLEC	
	Convection term accuracy	1st/2nd order (MUSCL/QUICK) upwind scheme, 2nd-order central difference (LES)		1st/2nd order (MUSCL/QUICK) upwind scheme, 2nd-order central difference (LES)	
	Matrix	MILUCG-STAB, AMGGC-STAB, CGCCG-STAB		MILUCG-STAB, AMG, AMGGC-STAB, CGCCG-STAB	
	Density based	• (defect correction method, JFNK method)		• (defect correction method)	
Flow types	Hypersonic solver	•			
	Steady-state / transient calculation	•		•	
	Incompressible fluid	•		•	
	Compressible fluid	•		•	
	Non-Newtonian fluid	•		•	
	Buoyancy (Boussinesq approximation)	•		•	
Turbulence models	Multiple fluids	•		•	
	Gas mixing	•		•	
Thermal analysis	Standard k-ε model, RNG k-ε model, MP k-ε model, AKN linear low-Reynolds number k-ε model, Realizable k-ε model, SST k-ω model, MPAKN linear low-Reynolds number k-ε model, Spalart-Allmaras one equation model, LKE k-kL-ε model, SST-SAS model, LES, DES, DDES, IDDES		Standard k-ε model, RNG k-ε model, MP k-ε model, AKN linear low-Reynolds number k-ε model, GPC linear low-Reynolds number k-ε model, Non-linear low-Reynolds number k-ε model, Realizable k-ε model, SST k-ω model, MPAKN linear low-Reynolds number k-ε model, Spalart-Allmaras one equation model, LKE k-kL-ω model, SST-SAS model, LES, DES, VLES		
	Heat conduction (fluid / solid)	•		•	
	Convective heat transfer	•		•	
	Heat radiation (view factor)	•		•	
	Heat radiation (flux method)	•		•	
	Heat conduction panel	•		•	
	Moving heat conduction panel	•		•	
	Solar radiation	•		•	
	Joule heat	•		•	
	Mean radiation temperature calculation	•		•	
	Graphic output of rays from lamp	•		•	
	Diffusion analysis	Diffusivity	•		•
		SORET effect	•		•
		Passive scalar	•		•
	Index for ventilation efficiency / thermal comfort	PMV / SET*	•		•
Humidity / dew condensation analysis	Relative humidity / absolute humidity	•		•	
	Dew condensation	•		•	
Chemical reaction	Chemical reaction	•		•	
	Combustion reaction	• Eddy-dissipation model		• Eddy-dissipation model	
	Thermal CVD analysis	•		•	
Particle analysis	Marker particles	•		•	
	Mass particles	•		•	
	Charged particles	• (user-defined function)		• (user-defined function)	
	Spray model	•		•	
	Liquid film	•		•	
	Transforming dew condensation	•		•	
Discrete element method (DEM)	Transforming fluid / volume rate	• (VOF method)		• (VOF method)	
	Contact model	Linear spring dashpot model, Hertz-Mindlin model, Walton-Braun model			
	Cloth model	•			
	String model	•			
	Cluster model	•			
	Cohesion model	•			
	Thermal	•			
	Ad/desorption (Humidity)	•			
	Dissolution	•			
	Dynamic Domain	•			
Multiphase flow analysis	Free surface	• (VOF method, steady-state/transient, multiphase)		• (VOF method, transient)	
	Solidification / melting analysis	•		•	
	Boil / condensation	• (VOF method, Dispersed multiphase flow)		• (VOF method)	
	Evaporation / condensation	•		•	
	Cavitation model / erosion index	•		•	
Aerodynamic noise analysis	Dispersed multiphase flow	•		•	
	Population balance model	•		•	
	Flowcs Williams & Hawkins' equation	•		•	
	Weak compressible flow model	•		•	
Current analysis	Sound source detection model	•		•	
	Conductor current	•		•	
Thermo-regulation model	Conductor potential	•		•	
	JOS, JOS-2	•		•	
Flow conditions	Velocity	•		•	
	Volume flow rate	•		•	
	Mass flow rate	•		•	
	Power law	•		•	
	Pressure (static pressure / total pressure)	•		•	
	Natural inflow / outflow	•		•	
	Fan model	•		•	
	Wave generation, wave dissipation	•		• (VOF method)	
Windkessel model	•				

Functions (scFLOW, SC/Tetra)

			scFLOW	SC/Tetra
Solver	Thermal conditions	Fixed temperature	•	•
		Heat source	•	•
		Heat transfer coefficient	•	•
		Contact heat transfer coefficient	•	•
	Wall conditions	No-slip (stationary wall)	•	•
		Free-slip (symmetry wall)	•	•
		Log-law condition	•	•
		Low-Re-number adaptive wall function	•	•
		Surface roughness	•	•
	Pressure conditions	Wall model (LES)	•	•
		Fixed pressure	•	•
		Pressure loss	•	•
	Source conditions	Porous media	•	•
		Volume force / pressure loss	•	•
Heat generation		•	•	
Smoke source (diffusing materials)		•	•	
Turbulence generation		•	•	
Solid shear heating		•	•	
Simplified propeller model		•	•	
User-defined conditions	Simplified rotor model	•	•	
	Variables table / functions	•	•	
	Script functions (JavaScript)	•	•	
Calculation control environment	User-defined function (compilation required)	•	•	
	Job management	•	•	
	Monitoring the calculation status	•	•	
	Email notification of the calculation	•	•	
Output for visualization	VB interface	•	•	
Output post files	Wavelet transform	•	•	
Output for third party software		Software Cradle post files (FPH) Abaqus, NASTRAN, ACTRAN, Femtet, Adams, Marc JMAG-Designer, EMSolution, FlowNoise, GT-SUITE, FieldView	Software Cradle post files (FLD, IFLD) Abaqus, Nastran, Femtet, ADVENTUREcluster, JMAG-Designer, EMSolution, Optimus, Isight, modeFRONTIER, LMS Virtual.Lab, Actran, FlowNoise, GT-SUITE, KULI, Flowmaster, LOGE, EnSight, FieldView, AVS	
Postprocessor	Drawing functions	Mesh, vector, contour plots	•	•
		Isosurface, streamline, pathlines, volume rendering	•	•
		Geometry display	• (STL file, NFB file, Wavefront OBJ file)	•
		2D graph	•	•
		Mirror / periodical copy	•	•
	Drawing position / orientation	Vortex center	•	•
		Arbitrary plane, surface, entire volume, cylinder	•	•
		Streamlines, isosurface	•	•
		Pathlines	•	•
		Arbitrary scaling	•	•
	Special effects	Arbitrary pick	• (scalar / vector values)	•
		Oil flow	• (on plane / surface)	•
		Texture mapping	• (on plane / surface, arbitrary geometry with texture)	•
		Lighting, luster, gradation	• (preset, arbitrary)	•
		Transparency, water-like expression, shadow	•	•
		Ray, Cloth model, Surface of particle, Road line, Heat transfer, IPC-2581	•	•
	Animation	Photorealistic	•	•
		Vector animation	•	•
		Flow line animation	•	•
		Cut-plane sweeping	•	•
		Marker particle	• (turbulent diffusion effect)	•
		Automatic translation of view point	• (view / focus points can be set)	•
		Key-frame animation, Time line	•	•
	Analysis results	Animation interpolated between cycles	•	•
		Variable registration	•	•
		Integral (surface / volume)	• (scalar / vector integration)	•
		Comparison	• (clipping function, image compare)	•
		Projected area calculation	•	•
Automatic search of the local max / min positions		•	•	
Data image output	Import of CSV data	•	•	
	Automatic change of colorbar	• (preset, arbitrary)	•	
	Complex values data graphing	•	•	
	Microsoft BMP, JPEG, PNG	• (size, resolution adjustable)	•	
	CradleViewer	• (support steady-state / transient animation, attach to Office applications)	•	
Operation and control environment	AVI, WMV, MP4	•	•	
	VRLM, FBX, STL	•	•	
	Copy & paste 3D onto Powerpoint	•	•	
	Selectable help function	•	•	
	OpenGL emulation (Hardware acceleration, software rendering)	•	•	
	VB interface	•	•	
	Selectable mouse operation modes	•	•	
Partial open field file by SSH	•	•		

System Configuration

Product	Compliant OS	CPU, Memory, HDD	Graphics	Approx. size of analysis for scFLOW	Compiler Environment (User defined function) for scFLOW	MPI Library
scFLOW SC/Tetra	Windows	Windows 10, Windows 11 (Verified by Version 20H2) Windows Server 2016, Windows Server 2019	[CPU] 64bit(AMD64/ Intel64)	[Memory] Approx. 1 million elements/2.0GB	[Windows edition ¹⁾] Microsoft Visual Studio 2017 Microsoft Visual Studio 2019	Intel® MPI Library 2018 Update 5 or 2019 Update 10 (Windows), Update 11 (Linux) 7 ³⁾
	Linux ¹⁾	RedHat Enterprise Linux 7 (Verified by 7.9) RedHat Enterprise Linux 8 (Verified by 8.4) SUSE Linux Enterprise Server 12 (Verified by SP4) SUSE Linux Enterprise Server 15 (Verified by SP1, SP2)	[Memory] 8GB or more; depends on the number of elements	[Maximum number of elements (actual)] 1830 million	[Linux edition] GCC (GNU Compiler Collection) (Linux standard)	
		[HDD] 10GB for installation	[Graphics] Graphics card that supports OpenGL for Preprocessor/ Postprocessor	[Maximum degree of parallelism (actual)] 36864		

Windows is a registered trademark of Microsoft Corporation in the United States and other countries.
The official name of Windows is the "Microsoft® Windows® Operating System".
Microsoft Visual Studio is a registered trademark of Microsoft Corporation in the United States and other countries.
Linux is a trademark registered to Linus Torvalds in the United States and other countries.
Red Hat is a registered trademark of Red Hat, Inc. in the United States and other countries.
SUSE is a registered trademark of SUSE LLC.
All other product and service names mentioned are registered trademarks or trademarks of their respective companies.

¹⁾ Only compliant with Solver, Monitor and Meshing function of Preprocessor.

²⁾ Verified with Windows SDK (10.0.16299.0).

³⁾ Use Intel-MPI packaged in Cradle products. When activating on multiple machines, we recommend you use it under the environment that meets the Intel® MPI Library system requirements.

Visualize your multiphysics phenomena in one environment

Postprocessor regularly installed in Software Cradle products can be purchased separately

scPOST

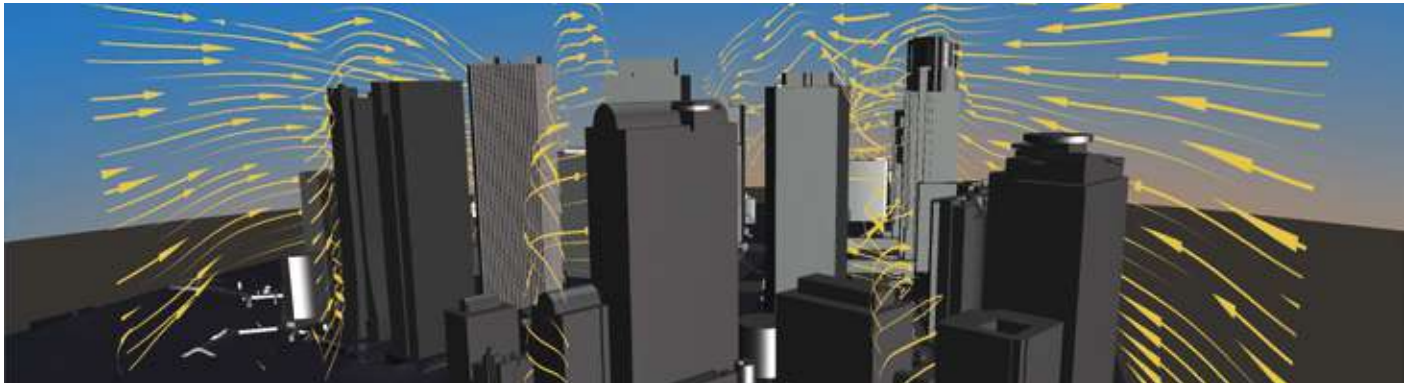

Postprocessor

In Postprocessor, you can visualize the simulation results calculated in Solver. It is effective for product design reviews because in Postprocessor, you can check, for example, temperature distribution at the places that cannot be measured or observed in the actual products. You can output not only still images but also animations, as well as output files for CradleViewer.

Characteristics

You can:

- Obtain numerical information with simple operation.
- Create beautiful animation quickly in Postprocessor.
- Easily map temperature information obtained in a fluid analysis to a structural analysis.
- Easily compare multiple analysis results.
- Easily calculate heat transfer and grasp a whole of heat-related matters.
- Output* images supporting VR.

*Output in the equirectangular format with parallax

Useful functions (example)

- Creates animation automatically
- Saves display status
- Develops the image on the meridian plane
- Compares results
- Calculates (integral, registering functions)

Drawing samples



Isosurface

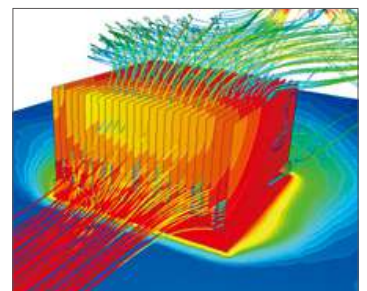

Contour



Oil flow

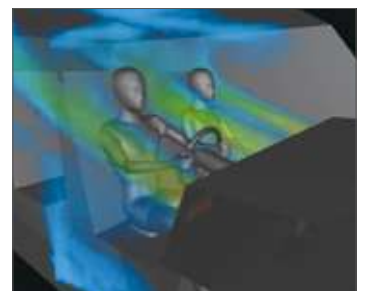

Volume rendering

Compatible formats for import/export

	Formats supported	Other format
Import	<ul style="list-style-type: none"> • MSC Nastran 2018.0 -2019.1 (.h5) • Marc 2018 (.t19, .t16) • Adams 2020 (.adm) • Generic format for fluid data (.cgns) [ADF only] 	<ul style="list-style-type: none"> • Images (BMP, PNG) • 3D geometry data (STL, OBJ) • Parasolid (Import Extension Option required)
Export	<ul style="list-style-type: none"> • Generic format for fluid data (.cgns) [Only ADF can be exported through scCONVERTER] 	<ul style="list-style-type: none"> • Images (BMP, JPEG, PNG) • Animation (AVI, WMV, MP4) • 3D geometry data (STL, VRML, FBX)

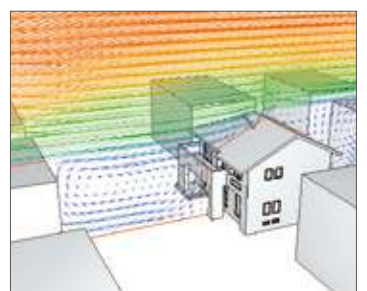

Vectors

Co-simulation with Hexagon CAE solutions

Integration of multidisciplinary analyses – from materials to systems

More realistic coupled fluid – mechanical – structural analyses

Capturing movement and deformation more precisely and expressing boundary conditions in fluid analyses with more reality

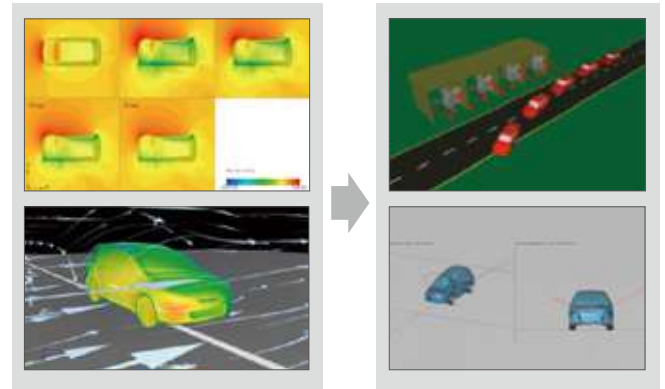
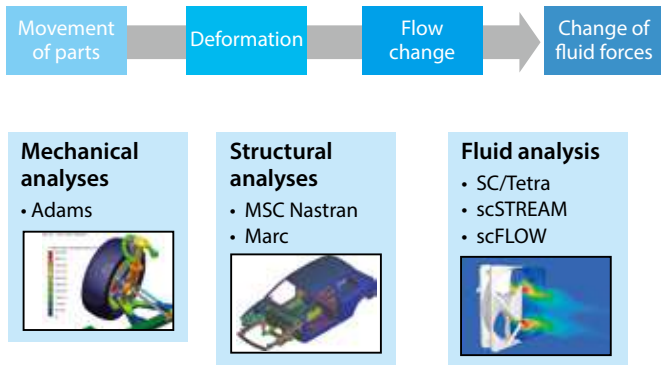

Analysis of aerodynamics characteristics per yaw angle

Assessment of crosswind stabilization in consideration of aerodynamics characteristics

Co-simulation platform

The platform for coupled analyses with MSC mechanical and structural analysis solvers provides seamless co-simulation.

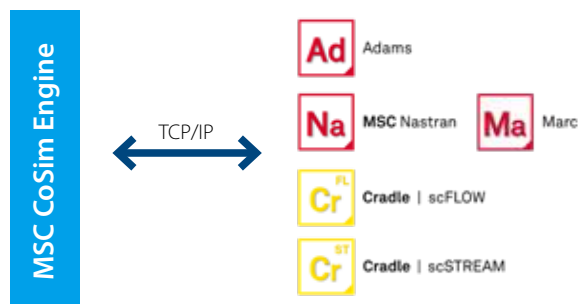

Co-simulation using FMI

Co-simulation using FMI a tool independent standard of 1D co-simulation interface

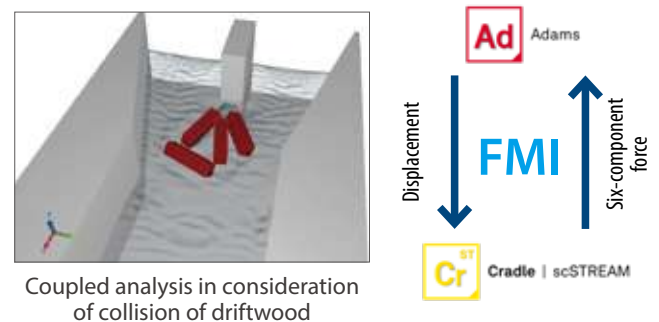

Coupled analysis in consideration of collision of driftwood

Co-simulation with Actran, acoustic analysis software

scFLOW and SC/Tetra are used to create fluid sound sources and Actran is used for propagation analysis of sound waves.

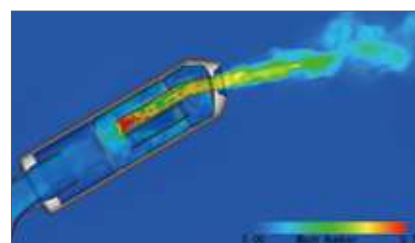
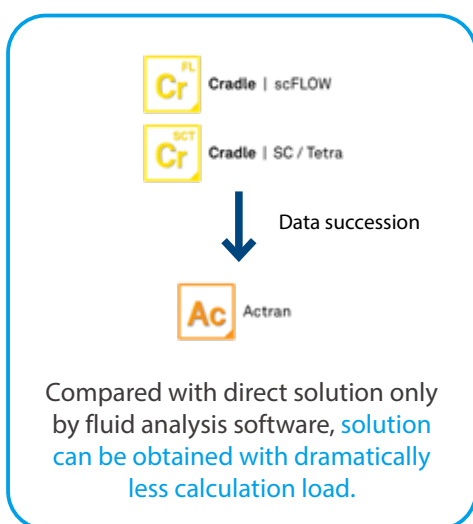

Analysis of an exhaust tube of a motorcycle



Analysis of an axial-flow fan

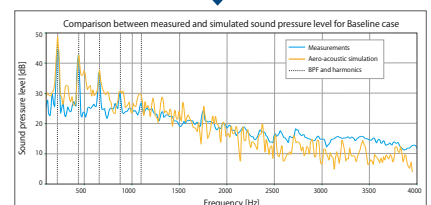

Acoustic analysis using fluid analysis results as a sound source

What is CAE?

scSTREAM | HeatDesigner

scFLOW | SC/Tetra

scPOST

Co-simulation with MSC Products

PICLS

Analysis Procedure

Main Mutual Features

Optimization Tool

License Type

Third-party Software

Wow! Was it this easy?!

Non-experts can start thermal analysis right away with easy operation in 2D and real-time results

PICLS PICLS Lite

PICLS is a **thermal simulation tool which helps designers easily perform thermal simulation of PCBs**. Even if you are unfamiliar with thermal simulation, you will obtain a simulation result without stress through the tool's easy and quick operation in 2D. You can import the data of a PCB created in PICLS to scSTREAM and HeatDesigner, that is, you can pass the analysis data seamlessly from the PCB design stage to the mechanical design stage.

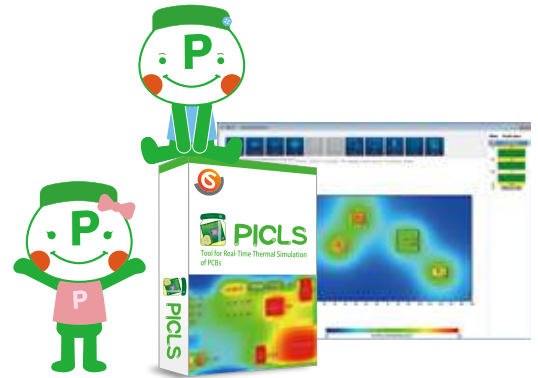

Advantages

- Easy to use
(Operation in 2D, integrated GUI for pre- and post-processing)
- Inexpensive
- Capable of real-time analysis

Thermal countermeasures using PICLS

- Checking the layout of components to avoid interference of heat between them
- Troubleshooting thermal issues of current products
- Considering heat release depending on a wiring pattern (coverage ratio)
- Examining the location and the number of thermal vias
- Examining the performance of a heatsink
- Examining the size of a PCB
- Examining the number of layers and the thickness of copper foil
- Considering natural/forced air cooling
- Considering radiant heat
- Considering heatsinks (number of fins, size)
- Examining heat dissipation performances by connection to enclosure
- Considering PCB mounting environment

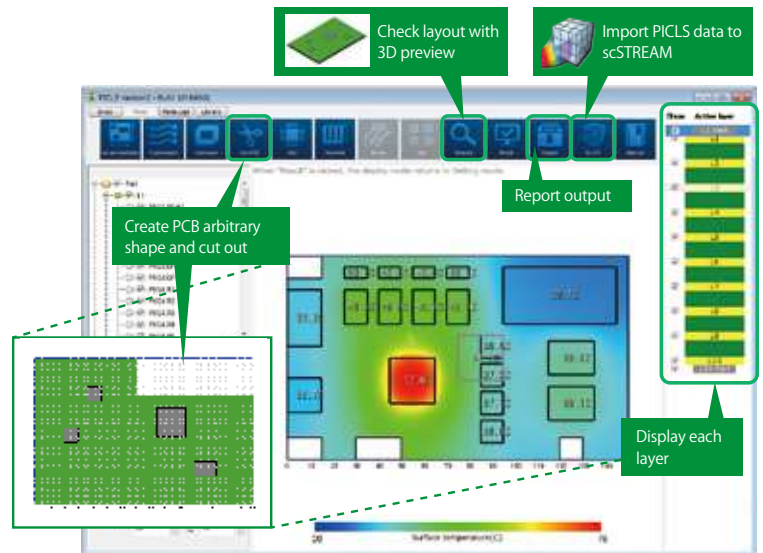

Functions available in PICLS and PICLS Lite

* PICLS Lite is provided online

- | | | |
|---------------------------------------------------|--------------------------------------------------------------|--------------------------------------------------------------------|
| <input type="radio"/> ...PICLS and PICLS Lite | <input checked="" type="radio"/> ...PICLS only | |
| <input type="radio"/> Multiple layers | <input type="radio"/> Wiring area specification | <input type="radio"/> Thermal via |
| <input type="radio"/> 3D preview | <input type="radio"/> Displaying each layer | <input type="radio"/> Cutting out a PCB |
| <input type="radio"/> Real-time display | <input type="radio"/> Automatic report output | <input type="radio"/> Forced air cooling |
| <input type="radio"/> Radiation | <input type="radio"/> Contact thermal resistance | <input type="radio"/> Temperature margin, alert function |
| <input checked="" type="radio"/> IDF3.0 interface | <input checked="" type="radio"/> Considering a heatsink | <input checked="" type="radio"/> Consideration of simple enclosure |
| <input checked="" type="radio"/> Library | <input checked="" type="radio"/> Wiring data (Gerber) import | <input checked="" type="radio"/> Drill data import |

Main features of PICLS and PICLS Lite

Modeling

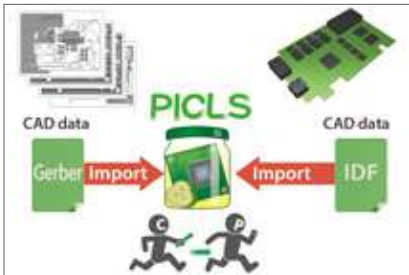

External file interface
You can import IDF 3.0 and Gerber data

PICLS

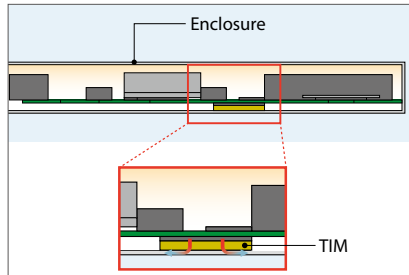

Consideration of simple enclosure
You can consider heat dissipation by connection to enclosure

PICLS

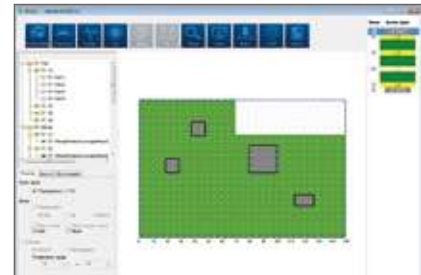

Cutting out a PCB
You can create a PCB of arbitrary shape using cut-out function.

PICLS
PICLS Lite

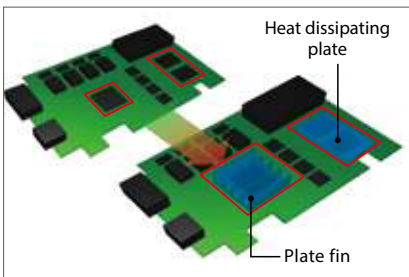

Heatsink
You can allocate and display parts such as plate fins and heat dissipation plates

PICLS

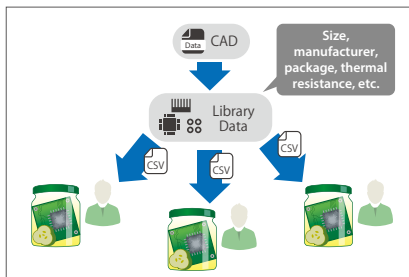

Library
You can register and reuse created parts to the library

PICLS

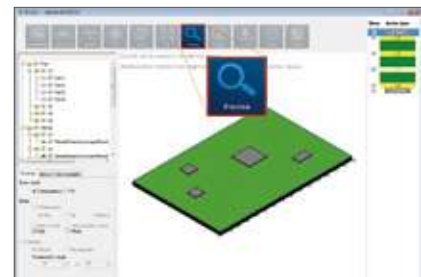

Preview
You can check the layout of components in the 3D image.

PICLS
PICLS Lite

Calculation and Post-Processing



Real-time display
The translation of components is displayed in real time.

PICLS
PICLS Lite

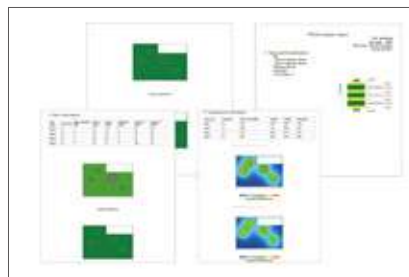

Report output
You can output analysis results as reports.

PICLS
PICLS Lite

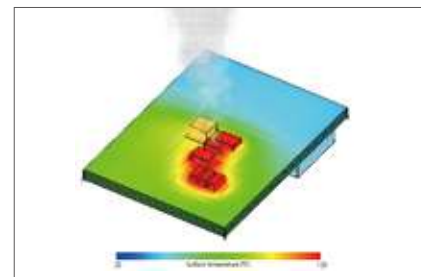

Alert function
You can check parts whose temperature is higher than threshold

PICLS
PICLS Lite

System Configuration

Compliant OS	Recommended environment
Windows 10 Windows Server 2016 RedHat Enterprise Linux 7 (Verified by 7.9) ^{*1} RedHat Enterprise Linux 8 (Verified by 8.4) ^{*1} SUSE Linux Enterprise Server 12 (Verified by SP4) ^{*1} SUSE Linux Enterprise Server 15 (Verified by SP1, SP2) ^{*1}	[Memory] 2.0 GB or more [Hard disk] 0.5 GB or more free capacity recommended [Display resolution] 1920 x 1080 or more

*1 Supports license manager only.

What is CAE?
 sCSTREAM | HeatDesigner
 sCFLOW | SC/Tetra
 sePOST
 Co-simulation with MSC Products
 PICLS
 Analysis Procedure
 Main Mutual Features
 Optimization Tool
 License Type
 Third-party Software

Analysis Procedure

–scSTREAM (HeatDesigner), scFLOW and SC/Tetra

There are three major steps in the workflow for obtaining simulation results.



STEP.1 Preprocessor

With Preprocessor, create or import analysis models, set analysis conditions, and generate mesh.



Create model
 Import CAD data
 Create model geometry

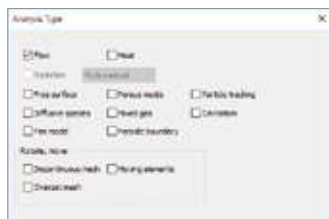

Set conditions
 Specify properties, steady-state / transient, heat, boundary conditions, etc



Set mesh density



Generate mesh

STEP.2 Solver

Flow/thermal calculations are performed using input data created in the Preprocessor. During the computation, calculation status can be monitored. The amount of time required for the computation depends on the size of the model (number of mesh elements), quality of the model, and hardware. A parallel Solver is available for reducing the computational time of large-scale models.

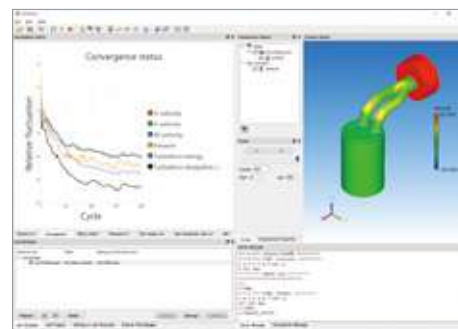

* See page 25 (HPC Solution) for more information about parallel calculation

Calculate

- **Solver features (examples)**
 - Setting the degree of parallelism
 - Monitoring job status
 - Visualizing results in real-time

STEP.3 Postprocessor

The Solver outputs field data for visualization using the Postprocessor. This permits examining flow, temperature, pressure, and other analysis results. Visualized results can be converted to images, animations and/or CradleViewer (details on P23) files for later use.

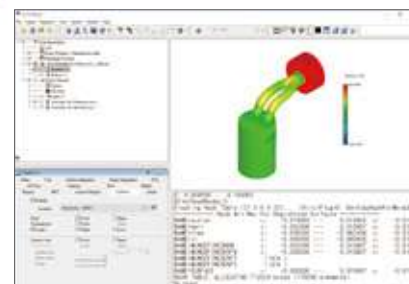

Visualize results

- **Various drawing functions**
 - Vector plot
 - Contour map
 - Streamline
 - Oil flow
 - Isosurface
 - Pathline (available only in SC/Tetra)
 - CradleViewer file output
 - Still image and animation output

Main Mutual Features

CAD Interface

ST : scSTREAM **HD** : HeatDesigner **FLOW** : scFLOW **SCT** : SC/Tetra

Software Cradle analysis software can import native data from major 3D CAD software as well as import most generalized intermediate data formats to save hassle for data conversion processes.

	CAD / geometry data	Compliant software	Format	Compliant versions	
Import	CATIA V6 / 3DEXPERIENCE	ST HD FLOW	3dxml	R2010x - R2021x	
	CATIA V5	ST HD FLOW SCT	CATPart, CATProduct	R10 - R31 (6R2021)	
	CATIA V4	ST HD FLOW SCT	model, exp, session	All 4.xx	
	Creo Elements/Pro (Pro/E)	ST HD FLOW SCT	part, asm	13 - Creo 8.0	
	SOLIDWORKS	ST HD FLOW SCT	sldprt, sldasm	95 - 2021 (ST, HD: Add in compliant with 2015 - 2018)	
	UG NX	ST HD FLOW SCT	prt	11 - NX1973	
	SolidEdge	ST HD FLOW	par, psm, asm	10 - 2021	
	Rhino	ST HD FLOW SCT	3dm	4 - 6	
	Autodesk® Inventor®	ST HD FLOW SCT	ipt, iam	Up to V2022	
	Autodesk® Revit®	ST	Compliant with Launcher	2019 - 2021	
	ARCHICAD	ST	Compliant with Launcher	22 - 24	
	IGES	ST HD FLOW SCT	iges, igs	All	
	VDAFS	ST HD FLOW SCT	vda	All	
	ACIS	ST HD FLOW SCT	sat, sab, asat, asab	R1 - 2021 1.0	
	Parasolid	ST HD FLOW SCT	x_t (scFLOW only: xmt_txt, x_b, xmt_bin)	V7.1 ~ V33	
	STEP	ST HD FLOW SCT	stp, step	AP203, AP214, AP242	
	JT	ST HD FLOW	jt	BREP only	
	IFC	ST	ifc	BREP only for scFLOW	
	SHAPE	ST	shp	Polyline, polygon	
	3ds	ST	3ds	-	
	STL	ST HD FLOW SCT	stl	-	
	Nastran		FLOW SCT	nas	Model only
	SketchUp	ST		skp	Up to SketchUp 2015
	Abaqus®		FLOW SCT	inp	Supported by FacetEditor in scFLOW
	Plot3D		FLOW SCT	fmt, p2dfmt, p3dfmt, dat	Supported by FacetEditor in scFLOW
	CGNS		FLOW SCT	cgns	Supported by FacetEditor in scFLOW
DXF	ST HD FLOW SCT	dxf (3DFACE)		ST and HD only: Polymesh and 2D	
IDF	ST HD		brd, emn	IDF2.0, IDF3.0	
GERBER	ST HD		gbr, drl, ECAD native (CR5000, Allegro, OrCAD)	RS274D, RS274X, Excellon	
IP-2581	ST HD		xml	-	
EXCML	ST HD		excml	-	
Export	Parasolid	ST HD FLOW SCT	x_t, xmt_txt, (x_b, xmt_bin: SCT only)	ST and HD: V31 - 33, FLOW: V323	
	STL	ST HD FLOW SCT	stl	Supported by FacetEditor in scFLOW	
	Nastran		FLOW SCT	nas	Supported by FacetEditor in scFLOW
	CGNS		FLOW SCT	cgns	Supported by FacetEditor in scFLOW

HPC (High Performance Computing) Solution

Large-scale, high-speed simulation with parallel computing technologies

Parallel computing makes possible solving existing models faster, conducting more analyses, and/or solving more detailed models with a greater number of mesh elements.

scSTREAM 2022

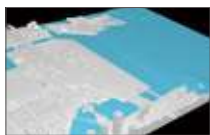

● Tsunami:
Approx. 56 million elements



● Projector:
Approx. 20 million elements

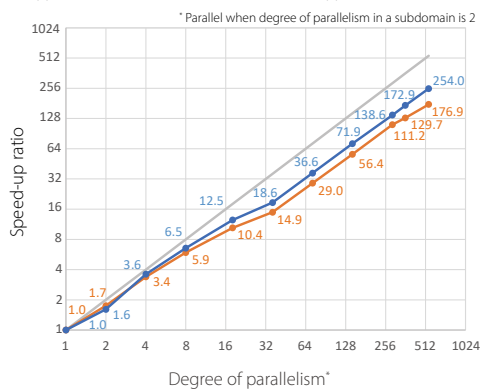

scFLOW 2022



● NASA CRM model:
Approx. 14 million elements

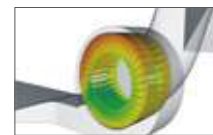

● Sirocco fan:
Approx. 13 million elements

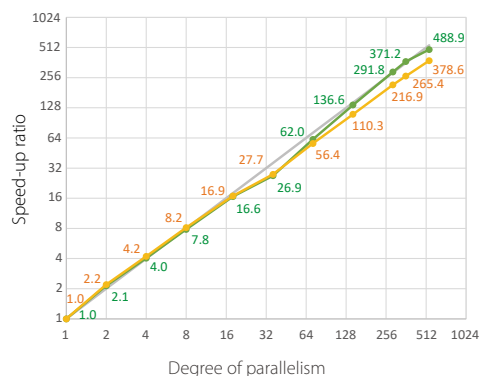

Main Mutual Features

scMonitor

You can visualize the progress of the simulations in scMonitor during the Solver calculations. You can check, for example, pressure contour of a registered surface and temperature contour and flow vector on axial planes.

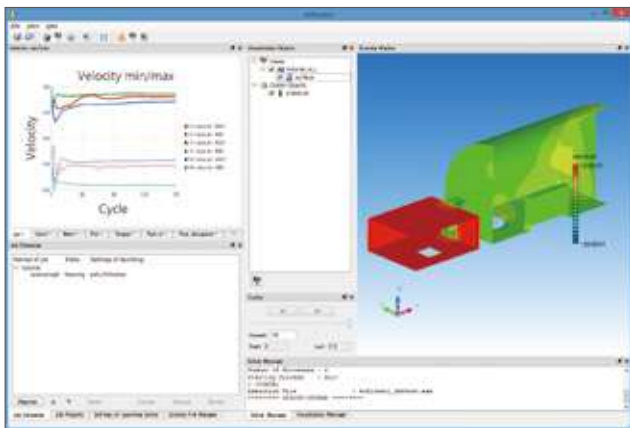

* To use this function, a Postprocessor license is required in some areas.

LFileView

LFileView is a dedicated viewer for L files, which are output during the simulations automatically. You can check the progress of the simulations numerically with variable values for each cycle and the maximum/minimum/average values for the specified output.

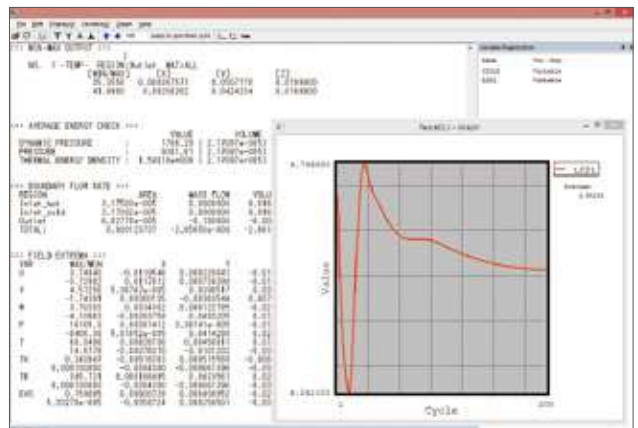

VB Interface

The software supports COM technology provided by Microsoft. You can control the software by using Microsoft Office products and Visual Basic (VB). A tool to create and execute the automatic operation flow, scWorkS ketch, is bundled with the software. By using the tool, you can create your original automatic operation flow easily. In addition, you can register the created flow as a template and reuse it.

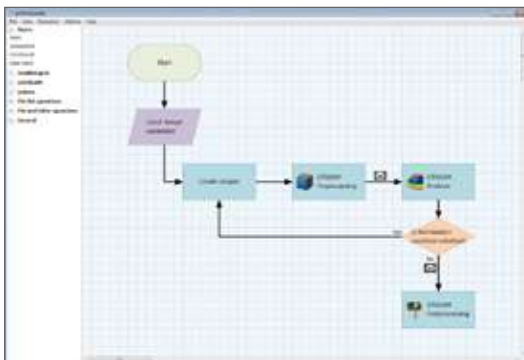

Useful functions

- Tool to create a report automatically
- Unique GUI
- Tool to create a model from the 2D data automatically

Parametric Study Tool

Using the parametric study tool, you can set analysis conditions to multiple cases all at once - for instance, when you run several calculations with modified parameters such as flow rate or amount of heat. The interface is user-friendly with spreadsheet-like settings. You can check, in the same interface, the status of each case and the output parameters such as the maximum/minimum temperature or average pressure on a specified plane.

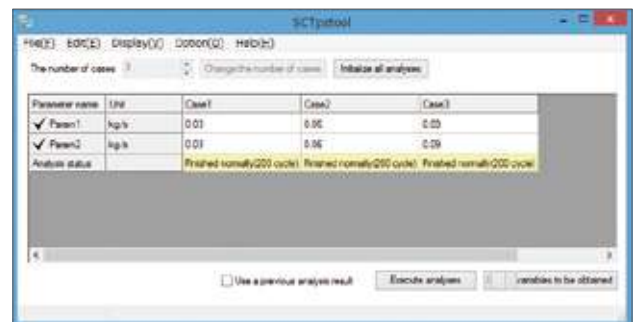

* This tool is available in scSTREAM, HeatDesigner, and SC/Tetra

CradleViewer

The simulation result visualized in Postprocessor can be saved in a file and the file can be opened in a simple viewer. In the viewer, the viewpoint and the distance can be changed with the mouse and by touch operation*. CradleViewer is provided free of charge. You can share the simulation result even in an environment without Postprocessor installed.

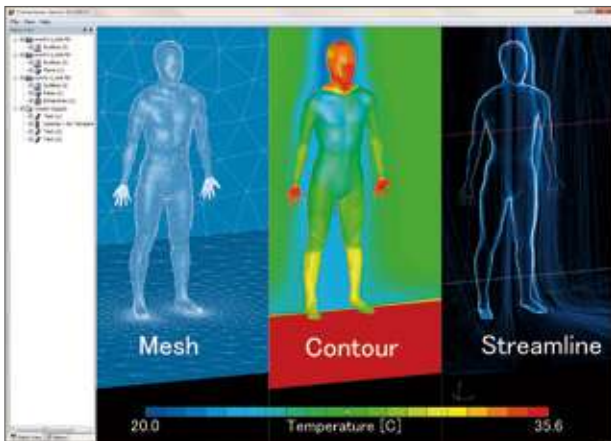

* Operation using two fingers is supported on a multitouch-compatible screen in a Windows 10 or Windows 8.1 environment.

** Compatible with Oculus Rift CV1 during VR mode.

HeatPathView

Using HeatPathView, you can review heat dissipation measures with focus on each component. The tool enables the intuitive and comprehensive evaluation of heat balance and search of heat dissipation paths. By understanding the flow of heat, you can make your heat dissipation designs more reliable.

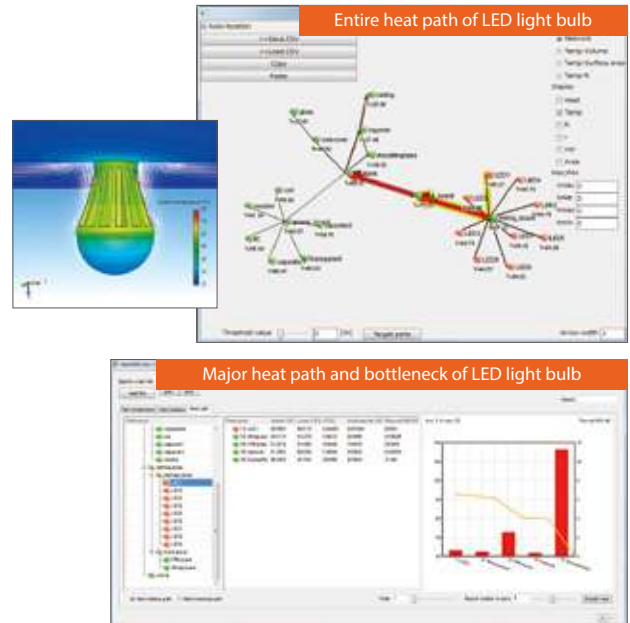

scCONVERTER

Data (FLD/FPH files) such as pressure, temperature, and heat transfer coefficient obtained in thermo-fluid analyses can be mapped to input data of structural analysis software (Abaqus, I-DEAS, Nastran). In addition, input data of structural analyses can be converted to an FLD or FPH file. scCONVERTER can create an animation file from multiple still images (BMP/PNG files), edit FLD/FPH files, and convert a P file to an FLD file or an FLD file to an iFLD file.

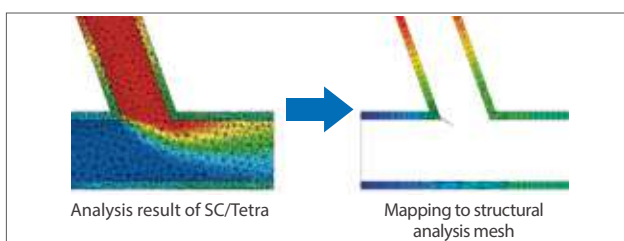

Introducing Optimus®

Optimus is an integration platform of simulation tools with optimization and automation as its cores

* Software Cradle handles Optimus® only in Japan



1. Optimus®

Optimus has a direct interface with scSTREAM, scFLOW and SC/Tetra, and the optimization can be performed without any additional customization. It also supports a creation of an original GUI using API and an optimization using Quality Engineering (Taguchi Method).

Automation/Integration

Executes the processes automatically just by constructing a simulation workflow with icons.

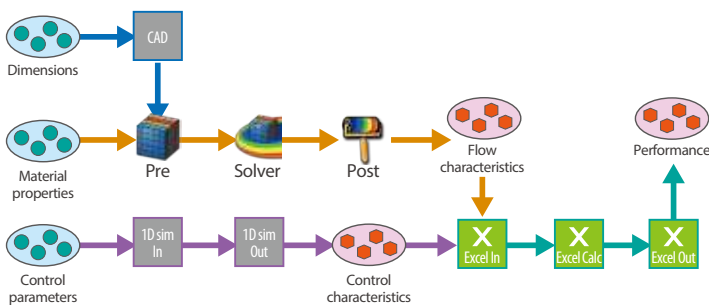

Data Mining

Visualizes data immediately. Relationships between the parameters can be grasped easily from sensitivity and correlation analyses.

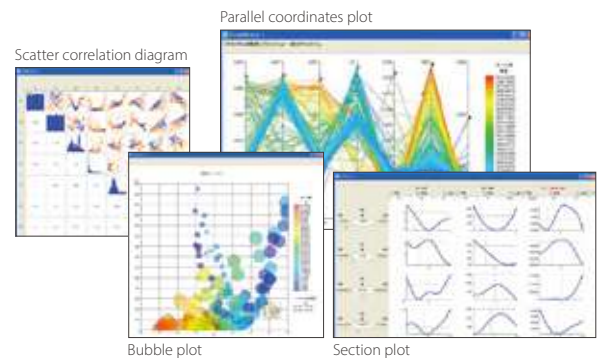

Optimization

Optimization algorithm automatically searches the parameters yielding the best performance.

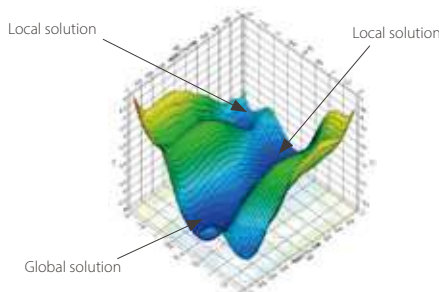

Robustness, Reliability

Predicts the variations in performance from the variations of parts. This enables the design with consideration on the variations in advance.

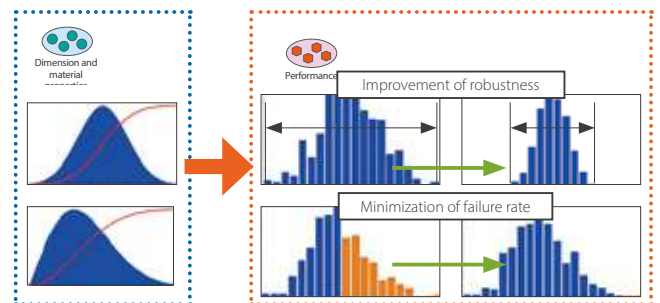

2. Optimus® for Cradle

Optimus® for Cradle is an optional tool which allows for the uses of optimization functions of Optimus directly on Software Cradle products. Optimization can be performed with ease, by inputting design variables and other parameters from the dedicated GUI.

Comparison Table: Optimus® and Optimus® for Cradle

		Optimus®	Optimus® for Cradle
Linkage to Software Cradle products	Condition setting	● (Direct interface)	● (Own GUI)
	Shape modification using CAD	● (Direct Interface)	—
Linkage to third party products	Simulation linkage	●	—
	DOE	Total 23 methods	Central Composite (inscribed), Latin-Hypercube
Calculation method	Response surface	All 5 + Optional 11 methods	Least squares, RBF (cubic)
	Single-objective optimization	Local: Total 5 methods Global: Total 7 + Optional 5 methods	NLPQL (local optimization)
	Multi-objective optimization	Total 11 + Optional 5 methods	NSEA+
	Robustness / Reliability / Quality Engineering	Total 7 methods, orthogonal table L4-512, static/dynamic characteristics	—
Postprocessing	Method	Total 23 types	Correlation diagram / scatter diagram / optimum solution / Pareto optimality
	Model	Total 13 types	Contour, contribution rate

License type

We provide various license types based on customer operations from on-premise to cloud

1. On-premise license: Features

- Underpriced
- Internally manageable machines
- Existing hardware resources
- No data transfer
- Internally controlled security
- In-house tools (e.g. automation)
- Multiple tools in combination

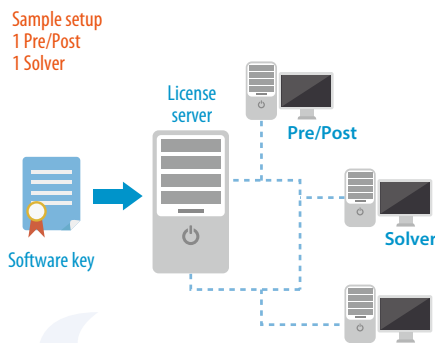

Recommended for customers who want to...

- Incorporate analysis into design workflow constantly and reduce cost
- Elaborate a combinational use of multiple analysis tools with a simple system
- Simplify analysis operations for obtaining design pointers and allow several users short-term uses

2. Cloud license: Features

- On-demand offer*¹
- No hardware required
- Large-scale calculations
- Support for sudden need
- No maintenance required
- Underpriced for infrequent users
- Not an asset

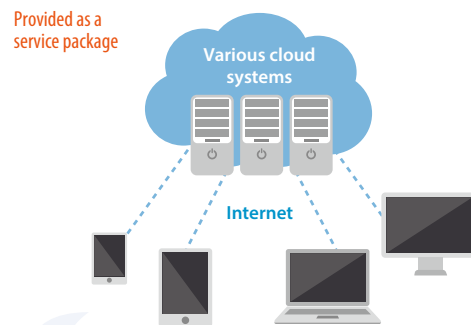

Recommended for customers who want to...

- Finish large-scale calculations in a short time although ordinary calculations can be performed with on-premise licenses
- Use outside resources temporarily because in-house resources is insufficient at the time
- Handle intensive calculation jobs efficiently for one project without placing burden on in-house resources

License type lookup table

			License	Agreement type			Remarks
			Network	Paid-Up	Lease	Cloud service* ¹ On-demand	
scSTREAM scFLOW & SC/Tetra	Pre/Post	Multi Cores	•	•	•	•	
		Unlimited Multi Cores	•	•	•	•	SC/Tetra is not available
	Solver	Multi Cores	•	•	•	•	
		Unlimited Multi Cores	•	•	•	•	SC/Tetra is not available
HeatDesigner	Pre/Solver/Post	Standard Set	•	•	•		
PICLS			•		•		
Optimus® for Cradle			•		•		

*1 Only available in a certain region

Links with other software

1. Electromagnetic Field Analysis Software

Using the data output from the electromagnetic analysis software, the effect of heat source distribution due to an electromagnetic field can be analyzed.

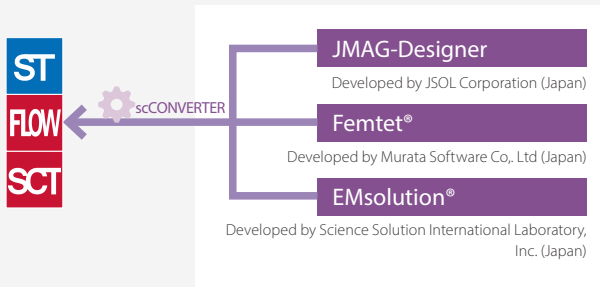

CMB File

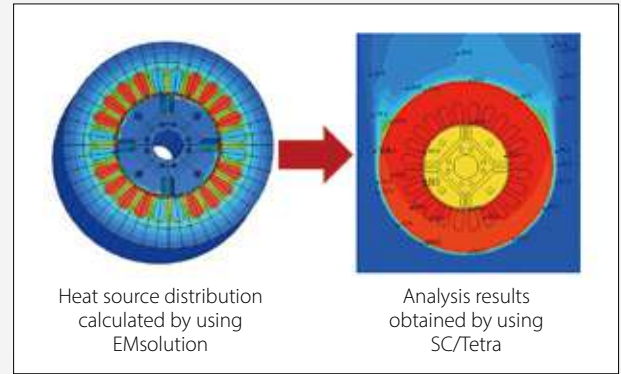

2. Acoustic Analysis Software

The acoustics of aerodynamic noise can be analyzed using scFLOW and SC/Tetra output data.

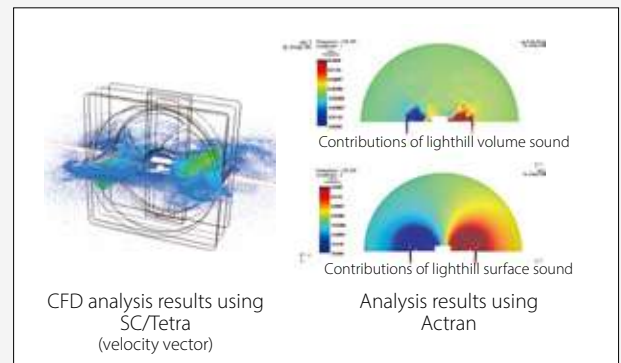
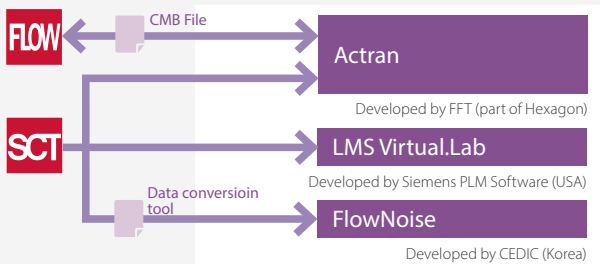

3. Structural Analysis Software

Using the output data from scFLOW, SC/Tetra and scSTREAM, structural analysis can include the influence of heat transfer and other fluid interactions.

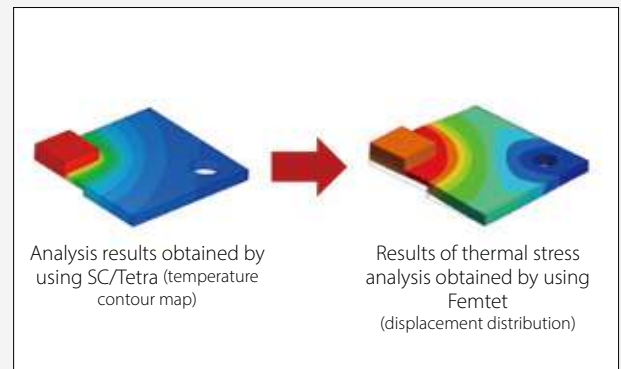
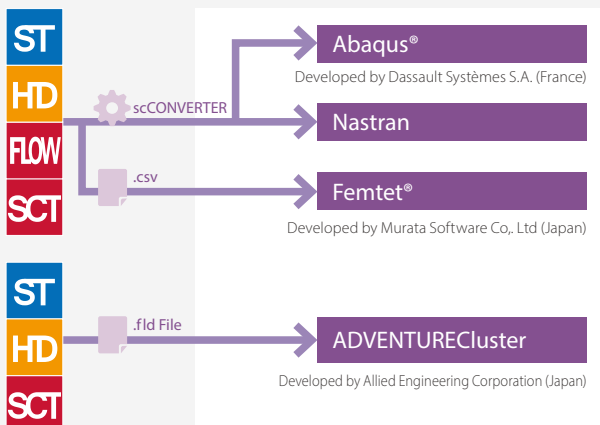

4. One-Dimensional Analysis Software

Computational load can be reduced by not solving all of the thermo-fluid analysis in three dimensions but using one-dimensional analysis software for some part.

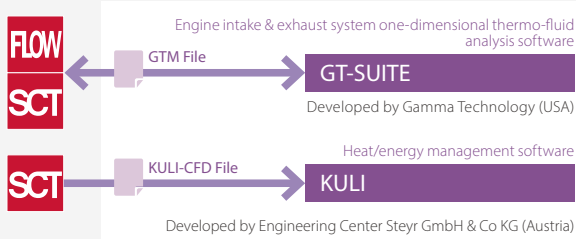

5. Chemical Reaction Analysis Software

Using material property parameters and chemical reaction database of LOGE, coupled analysis with SC/Tetra can be performed. This enables analysis of overall chemical reactions and detailed chemical reactions, which could not be analyzed by SC/Tetra alone.



6. 3D CAD Software

The direct interface (Launcher) equipped with scSTREAM enables the software to directly load original 3D CAD data.

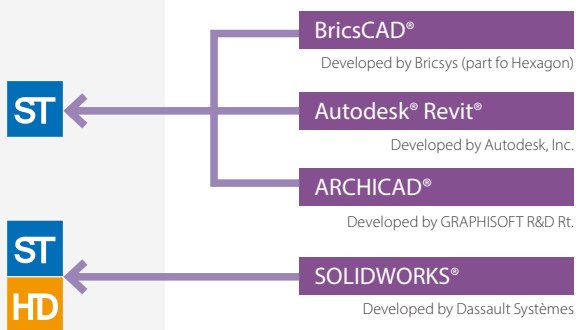

7. Optimization Software

Software Cradle products can be used in conjunction with optimization software for automation and/or optimizing product design.

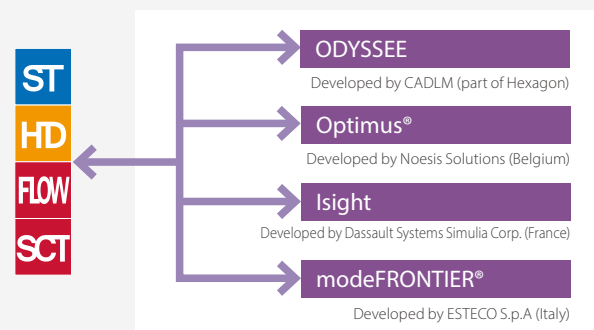

Optimus and modeFRONTIER have direct interface with SC/Tetra

8. Visualization Software

Read, visualize and edit FLD data (analysis results file from Software Cradle products) using other visualization software.

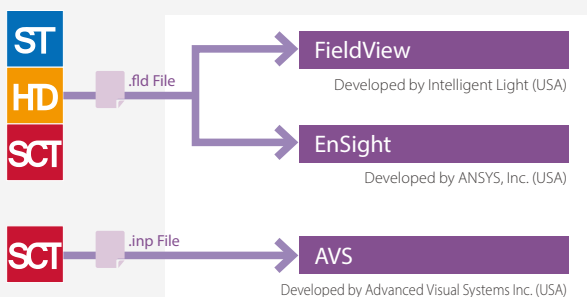

What is CAE?

scSTREAM | HeatDesigner

scFLOW | SC/Tetra

scPOST

Co-simulation with MSC Products

PICLS

Analysis Procedure

Main Mutual Features

Optimization Tool

License Type

Third-party Software



Osaka Head Office



Tokyo Office

About Software Cradle

Hexagon is a global leader in sensor, software and autonomous solutions. We are putting data to work to boost efficiency, productivity, and quality across industrial, manufacturing, infrastructure, safety, and mobility applications.

Our technologies are shaping urban and production ecosystems to become increasingly connected and autonomous - ensuring a scalable, sustainable future.

Software Cradle, part of Hexagon's Manufacturing Intelligence division, provides highly reliable, multiphysics-focused computational fluid dynamics (CFD), thermal dynamics software and integrated simulation tools that enhance customers' product quality and creativity. Hexagon's Manufacturing Intelligence division provides solutions that utilise data from design and engineering, production and metrology to make manufacturing smarter.

Learn more about Hexagon (Nasdaq Stockholm: HEXA B) at [hexagonmi.com](https://www.hexagonmi.com) and follow us [@HexagonAB](https://twitter.com/HexagonAB).

Software Cradle Co., Ltd.

• Osaka Head Office

Mainichi Intecio 3-4-5 Umeda,
Kita-ku, Osaka 530-0001 Japan
Phone : +81 (0)6 6343 5641
Fax : +81 (0)6 6343 5580

• Tokyo Office

KANDA SQUARE 2-2-1 Kandanishiki-cho,
Chiyoda-ku, Tokyo 101-0054 Japan
Phone : +81 (0)3 6275 0870
Fax : +81 (0)50 3153 0059



Contact Details

* All company names, products and service names mentioned are registered trademarks of the respective companies.

* Unauthorized use and reproduction of content, text, and images of this material is prohibited.

* Contents and specifications of products are as of June 30, 2022 and subject to change without notice.

We shall not be held liable for any errors in figures and pictures, or any typographical errors in this brochure.